



Servo-assisted 3/2, 5/2 or 5/3-way solenoid valve for pneumatics

- High flow-rate capacity
- Reduced power consumption
- Single or manifold mounting
- Standard, Ex mb, Ex eb mb and Ex ia versions
- Threaded port G 1/4", NPT 1/4" and NAMUR flange

Product variants described in the data sheet may differ from the product presentation and description.

Can be combined with

	Type 2507 ▶ Cable plug, form B according to industry standard
	Type 2516 ▶ Cable plug, form C according to DIN EN 175301-803
	Type 2518 ▶ Cable plug, form A according to DIN EN 175301-803
	Type 2030 ▶ Pneumatically operated 2/2 way diaphragm valve CLASSIC with plastic valve body
	Type 1087 ▶ Timer, form A according to DIN EN 175301 - 803

Type description

The Type 6518 is a servo-assisted 3/2-way valve and the Type 6519 is a 3/2, 5/2 or 5/3-way valve. Together, they form a product line. The valves can be used individually or in blocks. The valves work without a continuous air consumption and are used for the pneumatic control of double or single-acting actuators. The use of high quality materials makes it possible to use these valves in the open air and under chemical atmospheres. The product line contains units with Ex-Approvals and NAMUR flange interface.

Table of contents

1. General technical data	4
2. Product versions	5
2.1. Standard version.....	5
2.2. Ex mb- and Ex eb mb version.....	6
2.3. Ex ia version.....	7
2.4. NAMUR standard version	8
2.5. NAMUR Ex mb- and Ex eb mb version	9
2.6. NAMUR Ex ia version.....	10
2.7. Standard version for extended temperature range	11
2.8. Ex mb- and Ex eb mb version for extended temperature range.....	12
2.9. Ex ia version for extended temperature range	13
2.10. NAMUR version for extended temperature range.....	14
2.11. NAMUR Ex mb and Ex eb mb version for extended temperature range	15
2.12. NAMUR Ex ia version for extended temperature range.....	16
3. Circuit functions	17
4. Materials	17
4.1. Bürkert resistApp	17
5. Dimensions	18
5.1. Pneumatic module Type MP07	18
5.2. Standard version 5/2-way valve, circuit function H	19
With plug form B or C	19
With plug form A	20
5.3. Standard version 5/2-way valve, circuit function L and N	21
5.4. Ex mb/eb mb version 5/2-way valve, circuit function H	22
With moulded cable (3 m long) (Ex mb).....	22
With terminal box (Ex eb mb).....	22
5.5. Ex mb/eb mb version 5/2-way valve, circuit function L and N	23
With moulded cable (3 m long) (Ex mb).....	23
With terminal box (Ex eb mb).....	23
5.6. Ex ia version 5/2-way valve, circuit function H	24
5.7. NAMUR standard version 3/2-way valve, circuit function C or 5/2-way valve, circuit function H.....	25
With plug form B or C	25
With plug form A	26
5.8. NAMUR Ex mb/eb mb version 3/2-way valve, circuit function C or 5/2-way valve, circuit function H	27
With moulded cable (3 m long) (Ex mb).....	27
With terminal box (Ex eb mb).....	27
5.9. NAMUR Ex ia version 3/2-way valve, circuit function C or 5/2-way valve, circuit function H	28
5.10. Standard, Ex mb, Ex eb mb and Ex ia version or extended temperature range, circuit function H, L, N, Z (Impulse)	29
5.11. NAMUR Standard, Ex mb, Ex ebmb and -Ex ia version for extended temperature range, circuit function C, H, L, N, Z (Impulse).....	30
5.12. ATEX version cable coil and terminal box.....	31
6. Product design and assembly	32
6.1. Block construction	32
7. Product accessories	33
7.1. Cable glands for ATEX/IECEX terminal box	33
7.2. Special tool to turn the terminal box	33

8. Ordering information 33

8.1.	Bürkert eShop – Easy ordering and quick delivery	33
8.2.	Bürkert product filter	34
8.3.	Ordering chart standard version	34
	With plug form A	34
	With plug form B	35
	With plug form C	35
8.4.	Ordering chart Ex mb version (with moulded cable).....	36
8.5.	Ordering chart Ex eb mb version (with terminal box).....	37
8.6.	Ordering chart Ex ia version	38
8.7.	Ordering chart NAMUR standard version	39
	With plug form A	39
	With plug form B	40
	With plug form C	41
8.8.	Ordering chart NAMUR Ex mb version (with moulded cable).....	42
8.9.	Ordering chart NAMUR Ex eb mb version (with terminal box).....	43
8.10.	Ordering chart NAMUR Ex ia version	44
8.11.	Ordering chart for extended temperature range	45
	Standard, ematalised aluminium version	45
	Standard, stainless steel version	46
8.12.	Ordering chart Ex mb version for extended temperature range	47
	Ematalised aluminium version	47
	Stainless steel version.....	48
8.13.	Ordering chart Ex ia version for extended temperature range	49
	Ematalised aluminium version	49
	Stainless steel version.....	50
8.14.	Ordering chart NAMUR standard version for extended temperature range	51
	Ematalised aluminium version	51
	Stainless steel version.....	52
8.15.	Ordering chart NAMUR Ex mb version for extended temperature range	53
	Ematalised aluminium version	53
	Stainless steel version.....	54
8.16.	Ordering chart NAMUR Ex ia version for extended temperature range.....	55
	Ematalised aluminium version	55
	Stainless steel version.....	56
8.17.	Ordering chart accessories.....	57
	Cable plug Type 2518, form A according to DIN EN 175301 -803	57
	Cable plug Type 2513, form A according to DIN EN 175301 -803	57
	Cable plug Type 2507, form B according to industry standard	58
	Cable plug Type 2516, form C according to DIN EN 175301 -803	58
	Cable glands for ATEX/IECEX terminal box	59
	Throttle plate for NAMUR version	59
	Converting plate for NAMUR version.....	60

1. General technical data

Product properties	
Dimensions	Detailed information can be found in chapter "5. Dimensions" on page 18.
Material	
Body	Pilot valve: Polyamide, reinforced glass-fibre Main valve: Polyamide (5/2-way), aluminium (5/3-way)
Threaded bushing	Brass (stainless steel on request)
Seal	NBR and PUR (5/2-way), NBR (5/3-way)
Orifice	DN 8...DN 9
Performance data	
Switching time ^{1.)}	
Opening	Pressure build-up 0...10 %
Closing	Pressure reduction 100...90 %
Compressed air quality	ISO 8573 - 1:2010, class 7.4.4 ^{2.)}
Nominal operating mode	100 % continuous operation
Medium data	
Operating medium	Neutral medium, e.g. lubricated or non-lubricated compressed air
Process/Port connection & communication	
Pneumatic connection	Supply ports 1, 3, 5: Threaded G ¼, NPT ¼, flange-mountable Working ports 2, 4: Threaded G ¼, NPT ¼
Electrical connection	Plug form A acc. to DIN EN 175301 - 803 Plug form B acc. to DIN EN 175301 - 803 Plug form C acc. to DIN EN 175301 - 803
Product accessories	
Cable plug Type 2518 – form A (standard)	Detailed information can be found in chapter "Cable plug Type 2518, form A according to DIN EN 175301 - 803" on page 57.
Cable plug Type 2507 – form B (standard)	Detailed information can be found in chapter "Cable plug Type 2507, form B according to industry standard" on page 58.
Cable plug Type 2516 – form C (standard)	Detailed information can be found in chapter "Cable plug Type 2516, form C according to DIN EN 175301 - 803" on page 58.
Cable plug Type 2513 – form A for the EX area cat. 3	Detailed information can be found in chapter "Cable plug Type 2513, form A according to DIN EN 175301 - 803" on page 57.
Approvals and certificates	
Degree of protection	IP65 with cable plug
Environment and installation	
Installation position	Any, preferably actuator face up

1.) Measured at valve outlet at 6 bar and +20 °C.

2.) To prevent freezing of the expanded compressed air, the pressure dew point must be at least 10 K lower than the temperature of the medium.

2. Product versions

2.1. Standard version



Note:

For general technical data, see **"1. General technical data"** on page 4.

Type 6519 is a servo-assisted 5/2 or 5/3-way valve. The valve width of 32 mm allows high flow rates. The valves can be used separately or on blocks.

Product properties	Coil size 24.5 mm	Coil size 32 mm
Orifice	DN 8...DN 9	DN 8...DN 9
Switching time		
Opening	20 ms	20 ms
Closing	40 ms	40 ms
Weight	322 g (5/2-way)	478 g (5/2-way) 720 g (5/3-way)
Electrical data		
Operating voltage	24 V DC	24 V DC 24/ 110/ 230 V/ 50...60 Hz
Power consumption		
Inrush	-	AC: 11 VA AC: 6/2 VA/W
Hold (hot coil)	DC: 1.7 W	DC: 2 W
Medium data		
Medium temperature	- 10 °C...+55 °C	- 10 °C...+55 °C
Process/Port connection & communication		
Electrical connection	Plug form B acc. to DIN EN 175301 - 803 Plug form C acc. to DIN EN 175301 - 803	Plug form A acc. to DIN EN 175301 - 803
Environment and installation		
Ambient temperature	- 10 °C...+55 °C	- 10 °C...+55 °C

2.2. Ex mb- and Ex eb mb version

**Note:**

- Ex mb (with moulded cable) or Ex eb mb (with terminal box)
- The maximum medium temperature may never exceed the permissible temperature class (T4 135 °C, T5 100 °C, T6 85 °C) minus 5K.

The approval Ex mb is achieved by the mounting of an approved push-over coil. The cable connection and the cable are non-detachable and sealed together with the valve. The valves can be used individually or in blocks.



Product properties	
Orifice	DN 8...DN 9
Switching time	
Opening	20 ms
Closing	50 ms
Weight	700 g (5/2-way) 1100 g (5/3-way)
Electrical data	
Operating voltage	24 / 110 / 230 V / 50...60 Hz
Power consumption	
Hold (hot coil)	DC: 3 W
Medium data	
Medium temperature	-10 °C...+55 °C
Process/Port connection & communication	
Electrical connection	3 m cable, moulded Terminal box (without fuse)
Approvals and certificates	
Approval	
Coil with cable	EPS18 ATEX 1232 X / IECEx PTB 18.0110X II 2G Ex mb IIC T5 Gb II 2D Ex mb IIIC T95 °C Db
Coil with terminal box	EPS18 ATEX 1232 X / IECEx EPS 18.0110X II 2G Ex eb mb IIC T5 Gb II 2D Ex mb tb IIIC T95 °C Db
Environment and installation	
Ambient temperature	-10 °C...+55 °C

2.3. Ex ia version

**Note:**

- The maximum medium temperature may never exceed the permissible temperature class (T4 135 °C, T5 100 °C, T6 85 °C) minus 5K.
- The units may only be used in potentially explosive atmospheres in the manner approved by the admission board, i.e. the permissible maximum electrical values must be observed.
- The valve is intended for operation on 24 V DC outputs via the intermediate switching of a corresponding intrinsically-safe operating resource (isolating module or barrier).

The intrinsically-safe Type 6519 Ex ia valve consist of an intrinsically-safe pilot control and a pneumatic amplifier. The diaphragm-controlled valve seats work with very low friction, ensuring reliable switching of the valve, even after long shut-down periods.

Product properties

Orifice	DN 8...DN 9
---------	-------------

Switching time

Opening	75 ms
Closing	115 ms
Weight	670 g (5/2-way)

Electrical data

Function values for switching function valve	At +20 °C	At +55 °C
Minimum switching current	29 mA	29 mA
Nominal resistance coil	310 Ω	360 Ω
Minimum terminal voltage	9.0 V	10.4 V

Conformity specifications

Ui	35 V
Ii	0.9 A
Pi	1.1 W

Medium data

Medium temperature	-10 °C...+55 °C
--------------------	-----------------

Process-/Port connection & Communication

Electrical connection	Cable plug Type 2518, form A acc. to DIN EN 175301-803. Detailed information can be found in chapter " Cable plug Type 2518, form A according to DIN EN 175301-803 " on page 57.
-----------------------	--

Approvals and certificates

Approval	EPS 18 ATEX 1 088 / IECEx EPS 18.0038 X II 2G Ex ia IIC T6 Gb II 2D Ex ia IIIC T135 °C Db
----------	---

Environment and installation

Ambient temperature	-10 °C...+55 °C
---------------------	-----------------

2.4. NAMUR standard version

**Note:**

For general technical data, see "1. General technical data" on page 4.

The valve, made of high-quality polyamide, can be operated as a 5/2 or 3/2-way valve by varying the mounting position of the side changeover plate. The NAMUR flange pattern enables simple field mounting directly on the pneumatic actuator.

Product properties	Coil size 24.5 mm	Coil size 32 mm
Orifice	DN 6	DN 6
Switching time		
Opening	20 ms	20 ms
Closing	40 ms	40 ms
Weight	320 g	476 g
Electrical data		
Operating voltage	24 V DC	24 V DC 24/ 110/ 230 V/ 50...60 Hz
Power consumption		
Inrush	-	AC: 11 VA AC: 6/2 VA/W
Hold (hot coil)	DC: 1.7 W	DC: 2 W
Medium data		
Medium temperature	- 10 °C...+55 °C	- 10 °C...+55 °C
Process/Port connection & communication		
Electrical connection	Plug form B acc. to DIN EN 175301 - 803 Plug form C acc. to DIN EN 175301 - 803	Plug form A acc. to DIN EN 175301 - 803
Pneumatic connection		
Supply port 1, 3, 5	Threaded G ¼, NPT ¼	Threaded G ¼, NPT ¼
Working port 2, 4	NAMUR flange	NAMUR flange
Environment and installation		
Ambient temperature	- 10 °C...+55 °C	- 10 °C...+55 °C

2.5. NAMUR Ex mb- and Ex eb mb version



Note:

- Ex mb (with moulded cable) or Ex eb mb (with terminal box)
- The maximum medium temperature may never exceed the permissible temperature class (T4 135 °C, T5 100 °C, T6 85 °C) minus 5K.

The valve bodies are identical to those of the standard variants type 6519 NAMUR. The difference between the types is in the coils, which are designed and approved differently. By changing the coil on the valve housing, conversion from non-Ex operation to Ex operation (or vice versa) is very easy. Coil versions with moulded cable are plugged over and can be locked in 4 × 90° offset positions and positioned as required in between.

Product properties

Orifice	DN 6
---------	------

Switching time

Opening	20 ms
Closing	50 ms
Weight	690 g

Electrical data

Operating voltage	24 / 110 / 230 V / 50...60 Hz
-------------------	-------------------------------

Power consumption

Hold (hot coil)	DC: 3 W
-----------------	---------

Medium data

Medium temperature	-10 °C...+55 °C
--------------------	-----------------

Approvals and certificates

Approvals

Coil with cable	EPS18 ATEX 1232 X / IECEx PTB 18.0110X II 2G Ex mb IIC T5 Gb II 2D Ex mb IIIC T95 °C Db
Coil with terminal box	EPS18 ATEX 1232 X / IECEx EPS 18.0110X II 2G Ex eb mb IIC T5 Gb II 2D Ex mb tb IIIC T95 °C Db

Environment and installation

Ambient temperature	-10 °C...+55 °C
---------------------	-----------------

2.6. NAMUR Ex ia version



Note:

- The maximum medium temperature may never exceed the permissible temperature class (T4 135 °C, T5 100 °C, T6 85 °C) minus 5K.
- The units may only be used in potentially explosive atmospheres in the manner approved by the admission board, i.e. the permissible maximum electrical values must be observed.
- The valve is intended for operation on 24 V DC outputs via the intermediate switching of a corresponding intrinsically-safe operating resource (isolating module or barrier).

The intrinsically-safe Type 6519 Ex ia valve consist of an intrinsically-safe pilot control and a pneumatic amplifier. The diaphragm-controlled valve seats work with very low friction, ensuring reliable switching of the valve, even after long shut-down periods.

Type 6519 NAMUR Ex ia is used for pneumatic control of double- or single-acting actuators with NAMUR flange. The operating principle can be changed by simply turning the changeover plate. In the 3/2-way function, exhaust air is returned to the spring chamber of the valve actuator. The diaphragm-controlled valve seats operate with extremely low friction and switch reliably even after long downtimes and at ambient temperatures below zero degrees Celsius. The valve operates without constant air consumption.

Product properties		
Orifice	DN 6	
Switching time		
Opening	75 ms	
Closing	115 ms	
Weight	670 g	
Electrical data		
Function values for switching function valve	At +20 °C	At +55 °C
Minimum switching current	29 mA	29 mA
Nominal resistance coil	310 Ω	360 Ω
Minimum terminal voltage	9.0 V	10.4 V
Safety related highest values		
Ui	35 V	
Ii	0.9 A	
Pi	1.1 W	
Medium data		
Medium temperature	-10 °C...+55 °C	
Process/Port connection & communication		
Electrical connection	Cable plug Type 2518, form A acc. to DIN EN 175301 -803. Detailed information can be found in chapter " Cable plug Type 2518, form A according to DIN EN 175301 -803 " on page 57.	
Approvals and certificates		
Approval	EPS 18 ATEX 1 088 / IECEx EPS 18.0038 X II 2G Ex ia IIC T6 Gb II 2D Ex ia IIIC T135 °C Db	
Environment and installation		
Ambient temperature	-10 °C...+55 °C	

2.7. Standard version for extended temperature range



Product properties	Aluminium			Stainless steel		
Orifice	DN 9			DN 9		
Response times	5/2	5/2-bi	5/3	3/2	5/2	5/2-bi
Opening [ms]	16	18	16	13	12	14
Closing [ms]	27	18	22	47	74	14
Body material						
Pilot valve	Stainless steel			Stainless steel		
Main valve	Aluminium ematalised			Stainless steel 1.4571		
Threaded socket	Aluminium			Stainless steel		
Seal material	FPM, NBR			PU, NBR, FPM		
Compressed air quality	ISO 8573 - 1:2010, Class 7.2.4 ¹⁾					
Electrical data						
Operating voltages	24 V DC 24/ 110/ 230 V/ 50...60 Hz					
Voltage tolerance	+ 10 %					
Power consumption	2 W					
Duty cycle	100 % continuous operation					
Medium data						
Operating medium	Neutral medium, eg lubricated or non-lubricated compressed air					
Medium temperature	-30 °C...+80 °C			-30 °C...+80 °C		
Process/Port connection & communication						
Electrical connection	Cable plug Type 2518, form A acc. to DIN EN 175301 - 803. Detailed information can be found in chapter " Cable plug Type 2518, form A according to DIN EN 175301 - 803 " on page 57.					
Pneumatic connection						
Supply port 1, 3, 5	Threaded G ¼, NPT ¼					
Working port 2, 4	Threaded G ¼, NPT ¼					
Approvals and certificates						
Degree of protection	IP65 with cable plug					
Environment and installation						
Installation	As required, preferably with actuator upright					
Ambient temperature	-40 °C...+80 °C			-30 °C...+80 °C		

1.) To prevent freezing of the expanded compressed air, the pressure dew point must be at least 10 K lower than the temperature of the medium.

2.8. Ex mb- and Ex eb mb version for extended temperature range

**Note:**

- The maximum medium temperature may never exceed the permissible temperature class (T4 135 °C, T5 100 °C, T6 85 °C) minus 5K.

Product properties	Aluminium			Stainless steel		
Orifice	DN 9			DN 9		
Response times	5/2	5/2-bi	5/3	3/2	5/2	5/2-bi
Opening [ms]	16	18	16	13	12	14
Closing [ms]	27	18	22	47	74	14
Body material						
Pilot valve	Stainless steel			Stainless steel		
Main valve	Aluminium ematalised			Stainless steel 1.4571		
Threaded socket	Aluminium			Stainless steel		
Seal material	FPM, NBR			PU, NBR, FPM		
Compressed air quality	ISO 8573 - 1:2010, Class 7.2.4 ^{1.)}					
Electrical data						
Operating voltages	24 V DC 24/ 110/ 230 V/ 50...60 Hz					
Voltage tolerance	+ 10 %					
Power consumption	3 W					
Duty cycle	100 % continuous operation					
Medium data						
Operating medium	Neutral medium, eg lubricated or non-lubricated compressed air					
Medium temperature	-30 °C...+80 °C			-30 °C...+80 °C		
Process/Port connection & communication						
Electrical connection	3 m cable, moulded junction box (without fuse) on request					
Pneumatic connection						
Supply port 1, 3, 5	Threaded G ¼, NPT ¼					
Working port 2, 4	Threaded G ¼, NPT ¼					
Approvals and certificates						
Degree of protection	IP65					
Approvals						
Coil with cable	EPS18 ATEX 1232 X / IECEx PTB 18.0110X II 2G Ex mb IIC T5 Gb II 2D Ex mb IIIC T95 °C Db					
Coil with terminal box	EPS18 ATEX 1232 X / IECEx EPS 18.0110X II 2G Ex eb mb IIC T5 Gb II 2D Ex mb tb IIIC T95 °C Db					
Environment and installation						
Installation	As required, preferably with actuator upright					
Ambient temperature	-40 °C...+60 °C			-30 °C...+60 °C		

1.) To prevent freezing of the expanded compressed air, the pressure dew point must be at least 10 K lower than the temperature of the medium..

2.9. Ex ia version for extended temperature range

**Note:**

- The maximum medium temperature may never exceed the permissible temperature class (T4 135 °C, T5 100 °C, T6 85 °C) minus 5K.

Product properties	Aluminium			Stainless steel		
Orifice	DN 9			DN 9		
Response times	5/2	5/2-bi	5/3	3/2	5/2	5/2-bi
Opening [ms]	16	18	16	13	12	14
Closing [ms]	27	18	22	47	74	14
Body material						
Pilot valve	Stainless steel			Stainless steel		
Main valve	Aluminium ematalised			Stainless steel 1.4571		
Threaded socket	Aluminium			Stainless steel		
Seal material	FPM, NBR			PU, NBR, FPM		
Compressed air quality	ISO 8573-1:2010, Class 7.2.4 ^{1.)}					
Electrical data						
Function values for switching function valve	At +20 °C			At +55 °C		
Minimum switching current	29 mA			29 mA		
Nominal resistance coil	310 Ω			360 Ω		
Minimum terminal voltage	9.0 V			10.4 V		
Conformity specifications						
Ui	35 V					
Ii	0.9 A					
Pi	1.1 W					
Voltage tolerance	+10 %					
Medium data						
Operating medium	Neutral medium, eg lubricated or non-lubricated compressed air					
Medium temperature	-30 °C...+80 °C			-30 °C...+80 °C		
Process/Port connection & communication						
Electrical connection	Cable plug Type 2518, form A acc. to DIN EN 175301-803. Detailed information can be found in chapter “Cable plug Type 2518, form A according to DIN EN 175301-803” on page 57.					
Pneumatic connection						
Supply port 1, 3, 5	Threaded G ¼, NPT ¼					
Working port 2, 4	Threaded G ¼, NPT ¼					
Approvals and certificates						
Degree of protection	IP65 with cable plug					
Approval	EPS 18 ATEX 1 088 / IECEx EPS 18.0038 X II 2G Ex ia IIC T6 Gb II 2D Ex ia IIIC T135 °C Db					
Environment and installation						
Installation	As required, preferably with actuator upright					
Ambient temperature	-40 °C...+75 °C			-30 °C...+75 °C		

1.) To prevent freezing of the expanded compressed air, the pressure dew point must be at least 10 K lower than the temperature of the medium.

2.10. NAMUR version for extended temperature range



Product properties	Aluminium			Stainless steel		
Orifice	DN 6			DN 6		
Response times	5/2	5/2-bi	5/3	3/2	5/2	5/2-bi
Opening [ms]	16	18	16	13	12	14
Closing [ms]	27	18	22	47	74	14
Body material						
Pilot valve	Stainless steel			Stainless steel		
Main valve	Aluminium ematalised			Stainless steel 1.4571		
Threaded socket	Aluminium			Stainless steel		
Seal material	FPM, NBR			PU, NBR, FPM		
Compressed air quality	ISO 8573 - 1:2010, Class 7.2.4 ^{1.)}					
Electrical data						
Operating voltages	24 V DC 24/ 110/ 230 V/ 50...60 Hz					
Voltage tolerance	+ 10 %					
Power consumption	2 W					
Duty cycle	100 % continuous operation					
Medium data						
Operating medium	Neutral medium, eg lubricated or non-lubricated compressed air					
Medium temperature	-30 °C...+80 °C			-30 °C...+80 °C		
Process/Port connection & communication						
Electrical connection	Cable plug Type 2518, form A acc. to DIN EN 175301 - 803. Detailed information can be found in chapter " Cable plug Type 2518, form A according to DIN EN 175301 - 803 " on page 57.					
Pneumatic connection						
Supply port 1, 3, 5	Threaded G ¼, NPT ¼					
Working port 2, 4	NAMUR flange					
Approvals and certificates						
Degree of protection	IP65 with cable plug					
Environment and installation						
Installation	As required, preferably with actuator upright					
Ambient temperature	-40 °C...+80 °C			-30 °C...+80 °C		

1.) To prevent freezing of the expanded compressed air, the pressure dew point must be at least 10 K lower than the temperature of the medium.

2.11. NAMUR Ex mb and Ex eb mb version for extended temperature range

**Note:**

- The maximum medium temperature may never exceed the permissible temperature class (T4 135 °C, T5 100 °C, T6 85 °C) minus 5K.

Product properties	Aluminium	Stainless steel				
Orifice	DN 6	DN 6				
Response times	5/2	5/2-bi	5/3	3/2	5/2	5/2-bi
Opening [ms]	16	18	16	13	12	14
Closing [ms]	27	18	22	47	74	14
Body material						
Pilot valve	Stainless steel	Stainless steel				
Main valve	Aluminium ematalised	Stainless steel 1.4571				
Threaded socket	Aluminium	Stainless steel				
Seal material	FPM, NBR	PU, NBR, FPM				
Compressed air quality	ISO 8573 - 1:2010, Class 7.2.4 ^{1.)}					
Electrical data						
Operating voltages	24 V DC 24/ 110/ 230 V/ 50...60 Hz					
Voltage tolerance	+ 10 %					
Power consumption	3 W					
Duty cycle	100 % continuous operation					
Medium data						
Operating medium	Neutral medium, eg lubricated or non-lubricated compressed air					
Medium temperature	-30 °C...+80 °C			-30 °C...+80 °C		
Process/Port connection & communication						
Electrical connection	3 m cable, moulded junction box (without fuse) on request					
Pneumatic connection						
Supply port 1, 3, 5	Threaded G ¼, NPT ¼					
Working port 2, 4	NAMUR flange					
Approvals and certificates						
Degree of protection	IP65					
Approvals						
Coil with cable	EPS18 ATEX 1232 X / IECEx PTB 18.0110X II 2G Ex mb IIC T5 Gb II 2D Ex mb IIIC T95 °C Db					
Coil with terminal box	EPS18 ATEX 1232 X / IECEx EPS 18.0110X II 2G Ex eb mb IIC T5 Gb II 2D Ex mb tb IIIC T95 °C Db					
Environment and installation						
Installation	As required, preferably with actuator upright					
Ambient temperature	-40 °C...+60 °C			-30 °C...+60 °C		

1.) To prevent freezing of the expanded compressed air, the pressure dew point must be at least 10 K lower than the temperature of the medium..

2.12. NAMUR Ex ia version for extended temperature range

**Note:**

- The maximum medium temperature may never exceed the permissible temperature class (T4 135 °C, T5 100 °C, T6 85 °C) minus 5K.

Product properties	Aluminium			Stainless steel		
Orifice	DN 6			DN 6		
Response times	5/2	5/2-bi	5/3	3/2	5/2	5/2-bi
Opening [ms]	16	18	16	13	12	14
Closing [ms]	27	18	22	47	74	14
Body material						
Pilot valve	Stainless steel			Stainless steel		
Main valve	Aluminium ematalised			Stainless steel 1.4571		
Threaded socket	Aluminium			Stainless steel		
Seal material	FPM, NBR			PU, NBR, FPM		
Compressed air quality	ISO 8573-1:2010, Class 7.2.4 ^{1.)}					
Electrical data						
Function values for switching function valve	At +20 °C			At +55 °C		
Minimum switching current	29 mA			29 mA		
Nominal resistance coil	310 Ω			360 Ω		
Minimum terminal voltage	9.0 V			10.4 V		
Conformity specifications						
Ui	35 V					
Ii	0.9 A					
Pi	1.1 W					
Voltage tolerance	+10 %					
Medium data						
Operating medium	Neutral medium, eg lubricated or non-lubricated compressed air					
Medium temperature	-30 °C...+80 °C			-30 °C...+80 °C		
Process/Port connection & communication						
Electrical connection	Cable plug Type 2518, form A acc. to DIN EN 175301-803. Detailed information can be found in chapter “Cable plug Type 2518, form A according to DIN EN 175301-803” on page 57.					
Pneumatic connection						
Supply port 1, 3, 5	Threaded G ¼, NPT ¼					
Working port 2, 4	NAMUR flange					
Approvals and certificates						
Degree of protection	IP65 with cable plug					
Approval	EPS 18 ATEX 1 088 / IECEx EPS 18.0038 X II 2G Ex ia IIC T6 Gb II 2D Ex ia IIIC T135 °C Db					
Environment and installation						
Installation	As required, preferably with actuator upright					
Ambient temperature	-40 °C...+75 °C			-30 °C...+75 °C		

1.) To prevent freezing of the expanded compressed air, the pressure dew point must be at least 10 K lower than the temperature of the medium.

3. Circuit functions

Circuit functions	Description
	Circuit function C (CF C) 3/2-way solenoid valve Servo-controlled, with manual override Normally closed
	Circuit function H (CF H) 5/2-way solenoid valve Servo-controlled Pressure applied via port (1), therefore one of the two ports (2) or (4) is under pressure.
	Circuit function H (CF H) 5/2-way solenoid valve Servo-controlled, with manual override Pressure applied via port (1), therefore one of the two ports (2) or (4) is under pressure.
	Circuit function L (CF L) 5/3-way solenoid valve With manual override In middle position all ports locked Normally closed
	Circuit function N (CF N) 5/3-way solenoid valve With manual override In middle position ports 2 and 4 exhausted
5/2 	Circuit function W (CF W) 5/2- or 3/2-way solenoid valve With changeover plate
3/2 	5/2-way: Pressurisation via port (1). Therefore one of the two ports (2) or (4) is under pressure 3/2-way: Pressurisation via port (1), normally closed
5/2 	Circuit function W (CF W) 5/2- or 3/2-way solenoid valve With manual override With changeover plate
3/2 	5/2-way: Pressurisation via port (1). Therefore one of the two ports (2) or (4) is under pressure. 3/2-way: Pressurisation via port (1), normally closed
	Circuit function Z (CF Z) 5/2-way solenoid valve Impulse version with 2 coils and manual override Pressure applied via port (1), therefore one of the two ports (2) or (4) is under pressure.

4. Materials

4.1. Bürkert resistApp



Bürkert resistApp – Chemical Resistance Chart

You want to ensure the reliability and durability of the materials in your individual application case? Verify your combination of media and materials on our website or in our resistApp.

[Start Chemical Resistance Check](#)

5. Dimensions

5.1. Pneumatic module Type MP07

Note:

- Dimensions in mm
- n = no. of valves, maximum 12
- Block mounting on wall or with DIN rail 50022 or 50023
- Valve mounting on the pneumatic modules Type MP07 by means of included M4 screws

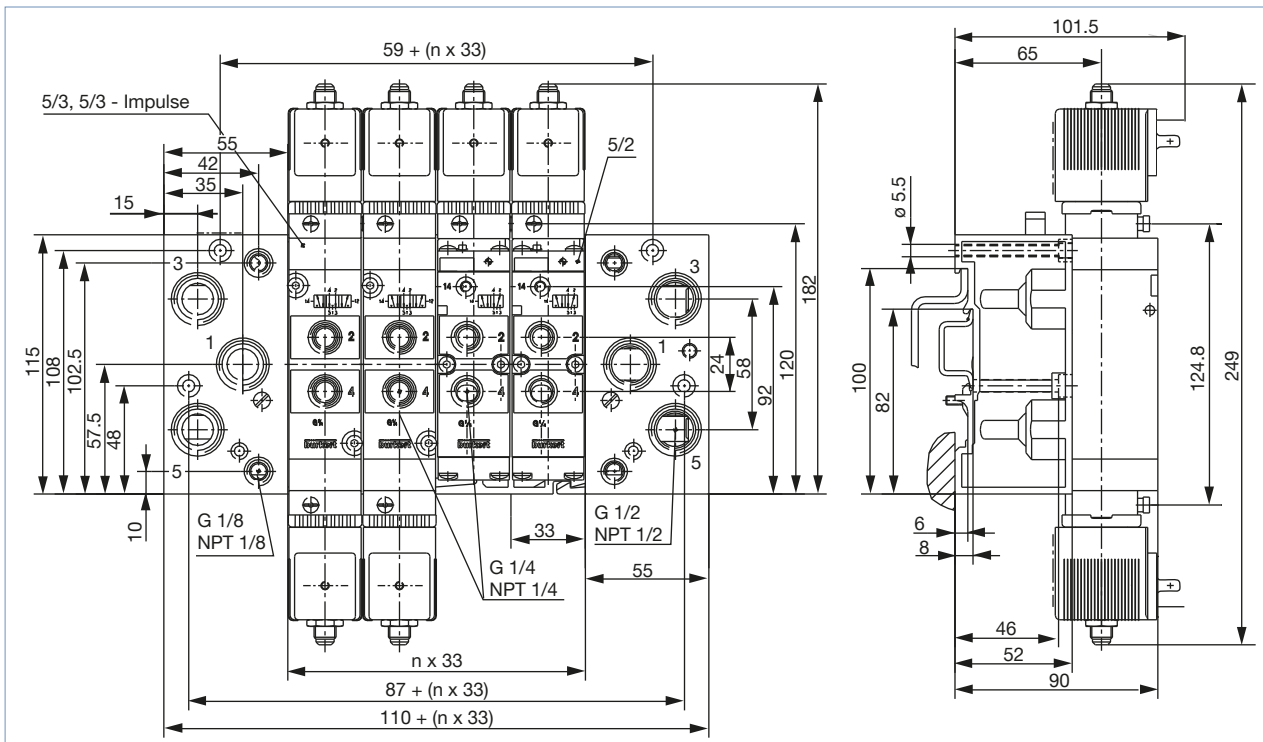

DTS 1000011067 EN Version: U Status: RL (released | freigegeben | valide) printed: 11.07.2023

5.2. Standard version 5/2-way valve, circuit function H

Note:
Dimensions in mm

With plug form B or C

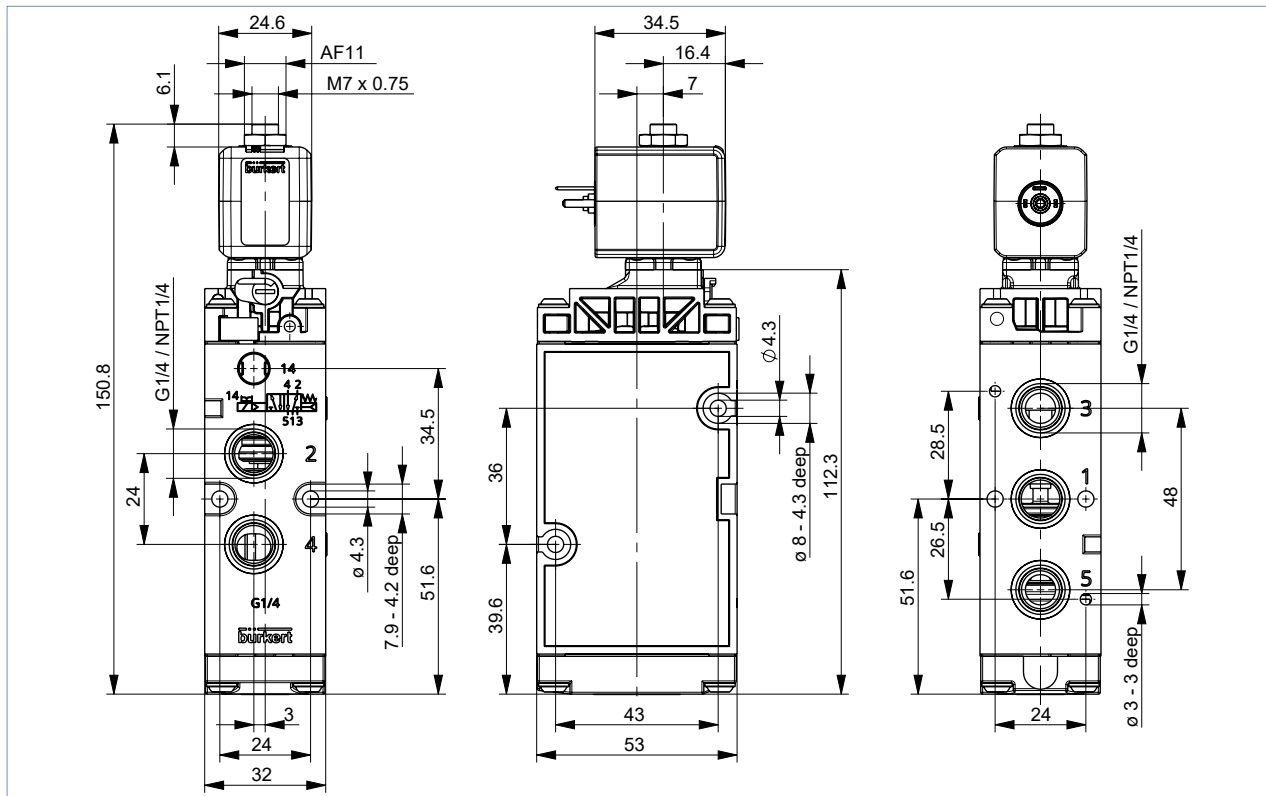

With plug form A

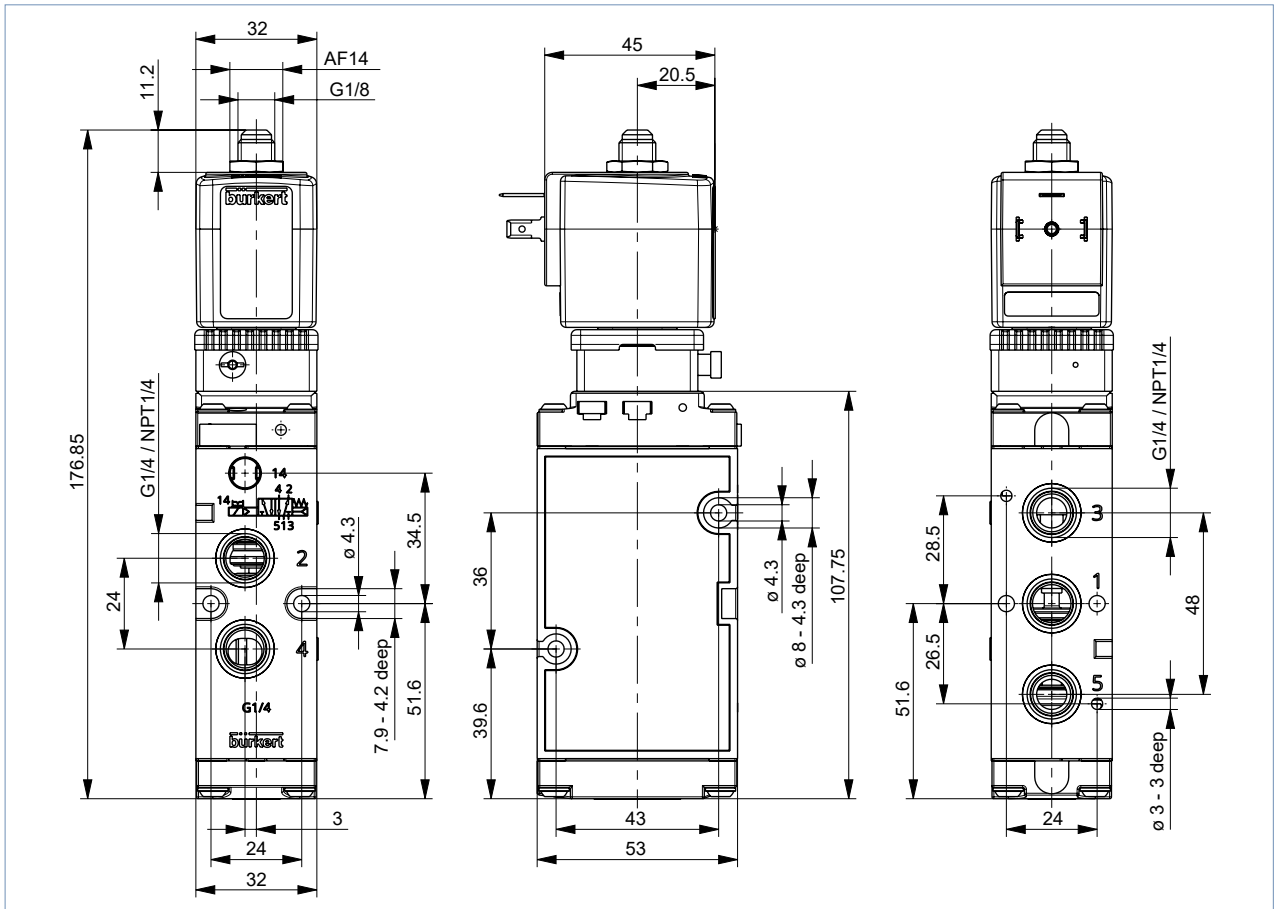

5.3. Standard version 5/2-way valve, circuit function L and N

Note:

- Dimensions in mm
- Installation length with 2 solenoids 249 mm

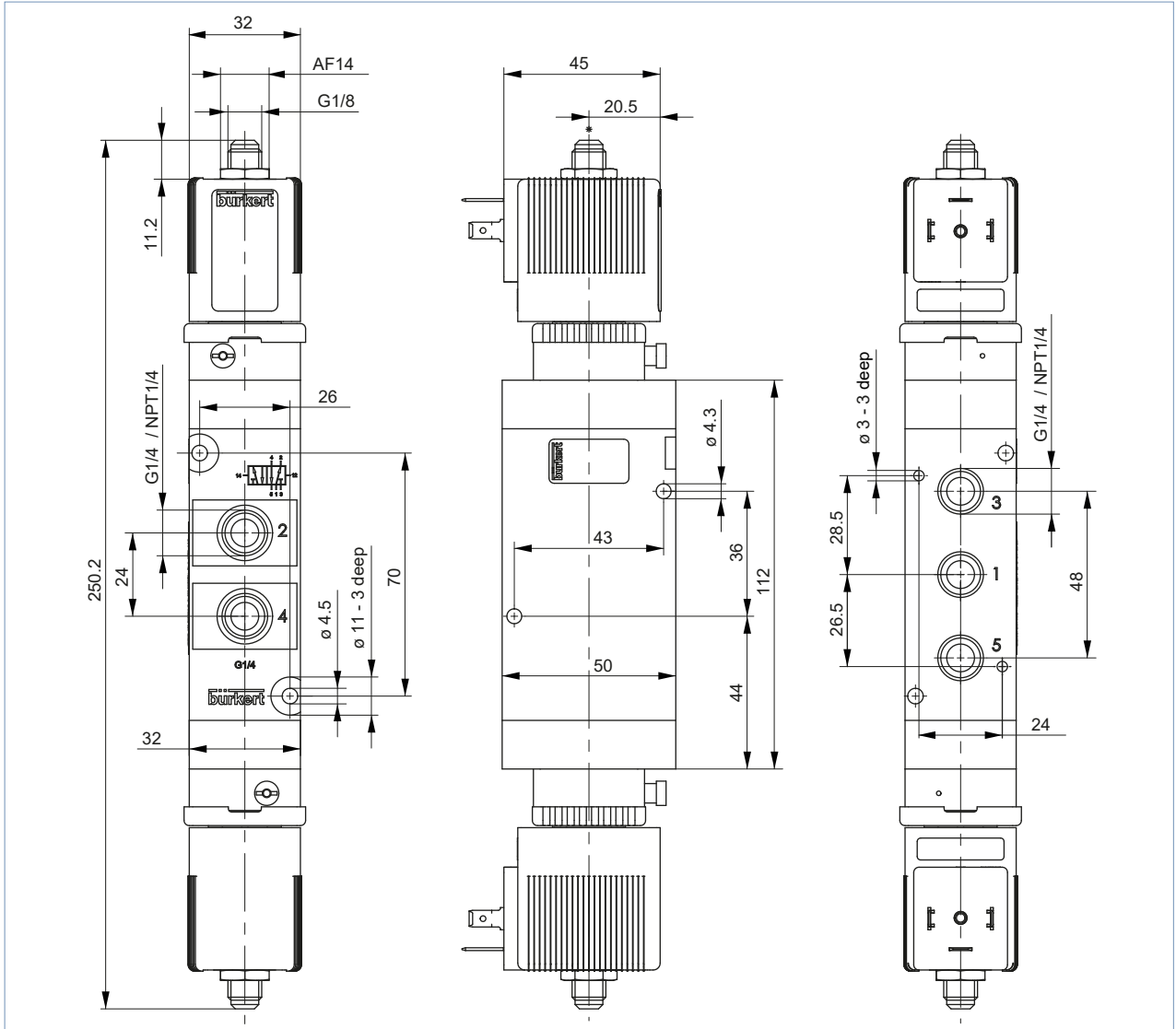

5.4. Ex mb/eb mb version 5/2-way valve, circuit function H

With moulded cable (3 m long) (Ex mb)

Note:

- Dimensions in mm
- For the coil dimensions, see chapter “5.12. ATEX version cable coil and terminal box” on page 31.

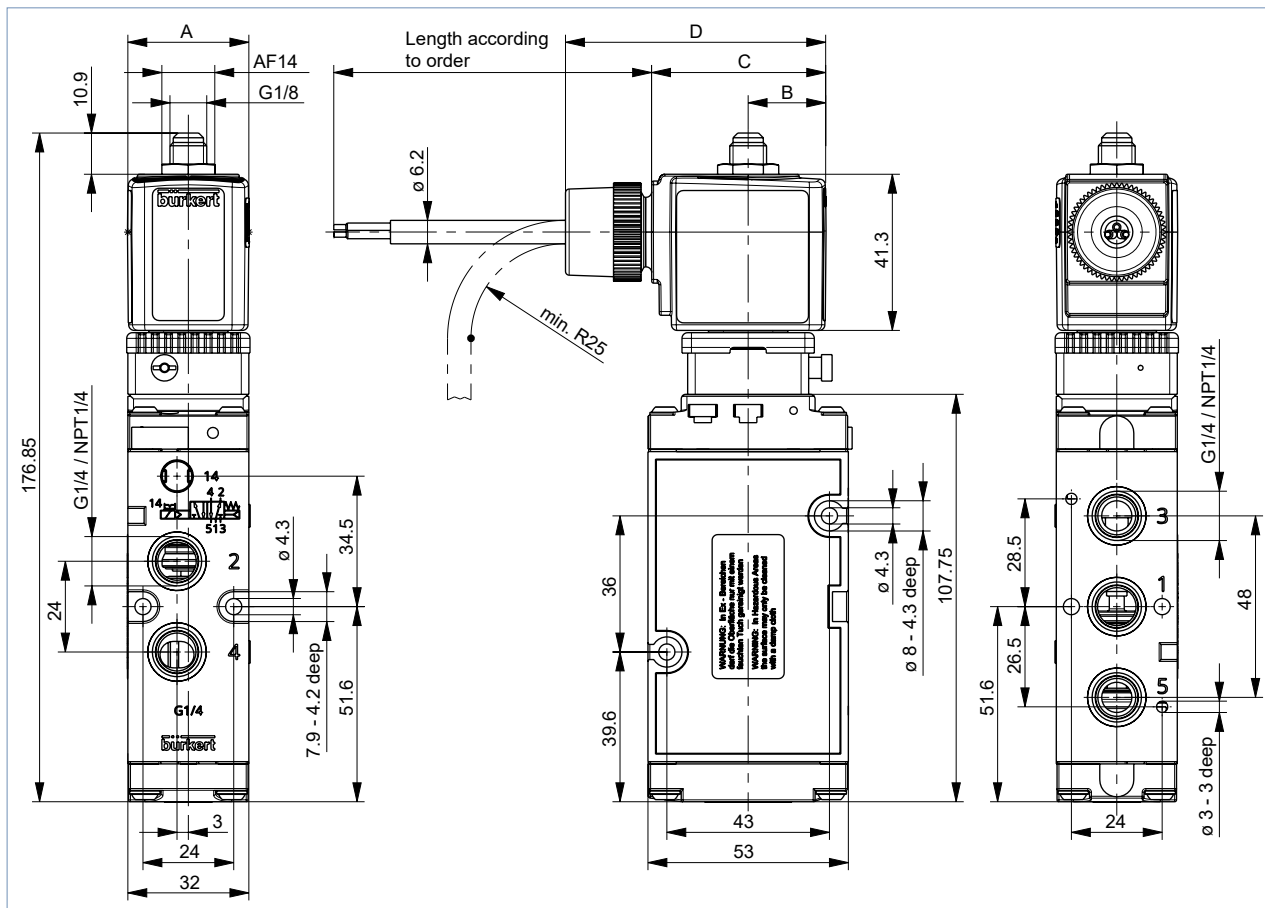

With terminal box (Ex eb mb)

Note:

- The dimensions of the housing are identical to the version with molded cable.
- Coil dimensions, see chapter “5.12. ATEX version cable coil and terminal box” on page 31.

5.5. Ex mb/eb mb version 5/2-way valve, circuit function L and N

With moulded cable (3 m long) (Ex mb)

Note:

- Dimensions in mm
- For the coil dimensions, see chapter “5.12. ATEX version cable coil and terminal box” on page 31.

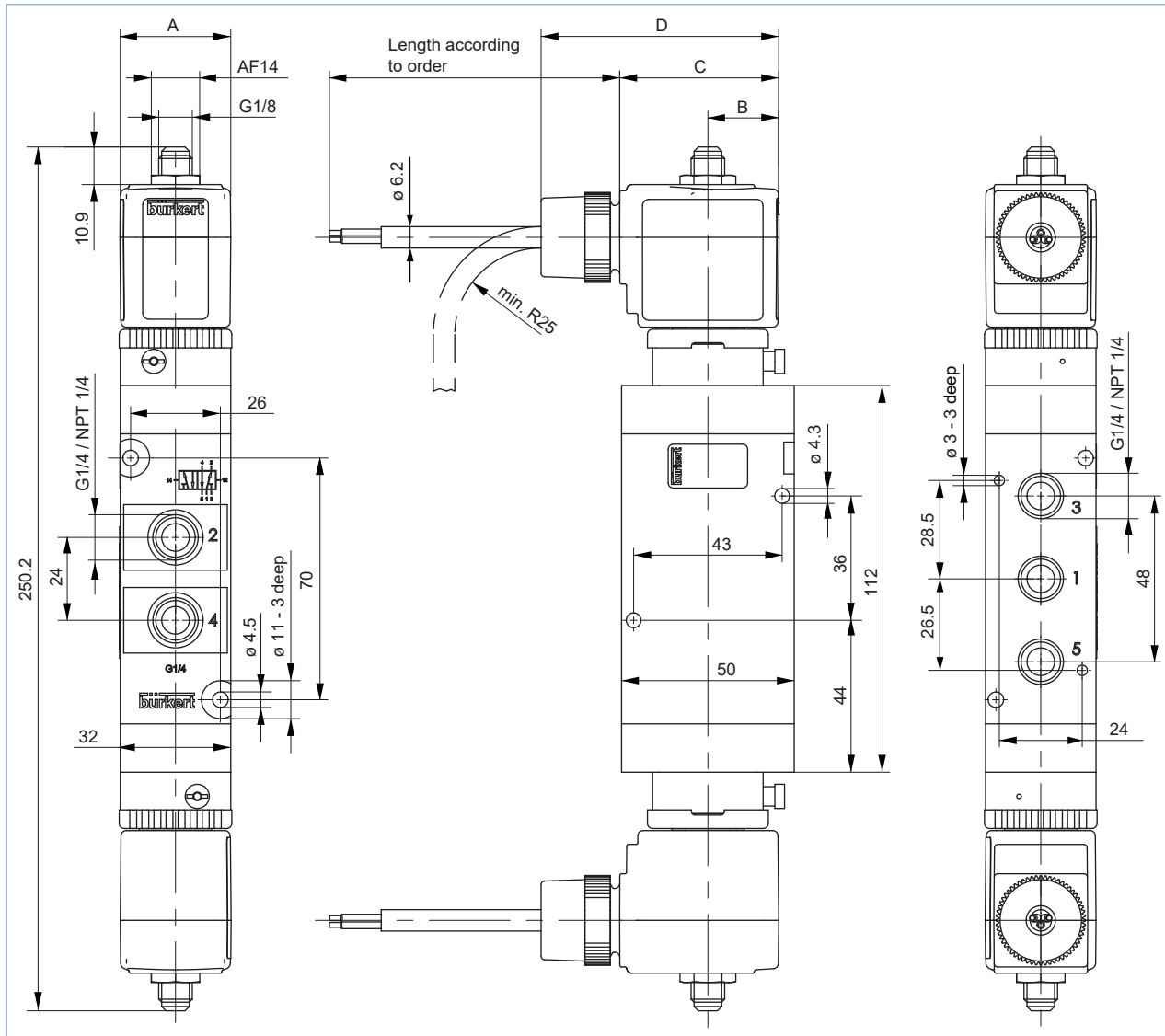

With terminal box (Ex eb mb)

Note:

- The dimensions of the housing are identical to the version with molded cable.
- For the coil dimensions, see chapter “5.12. ATEX version cable coil and terminal box” on page 31.

5.6. Ex ia version 5/2-way valve, circuit function H

Note:

Dimensions in mm

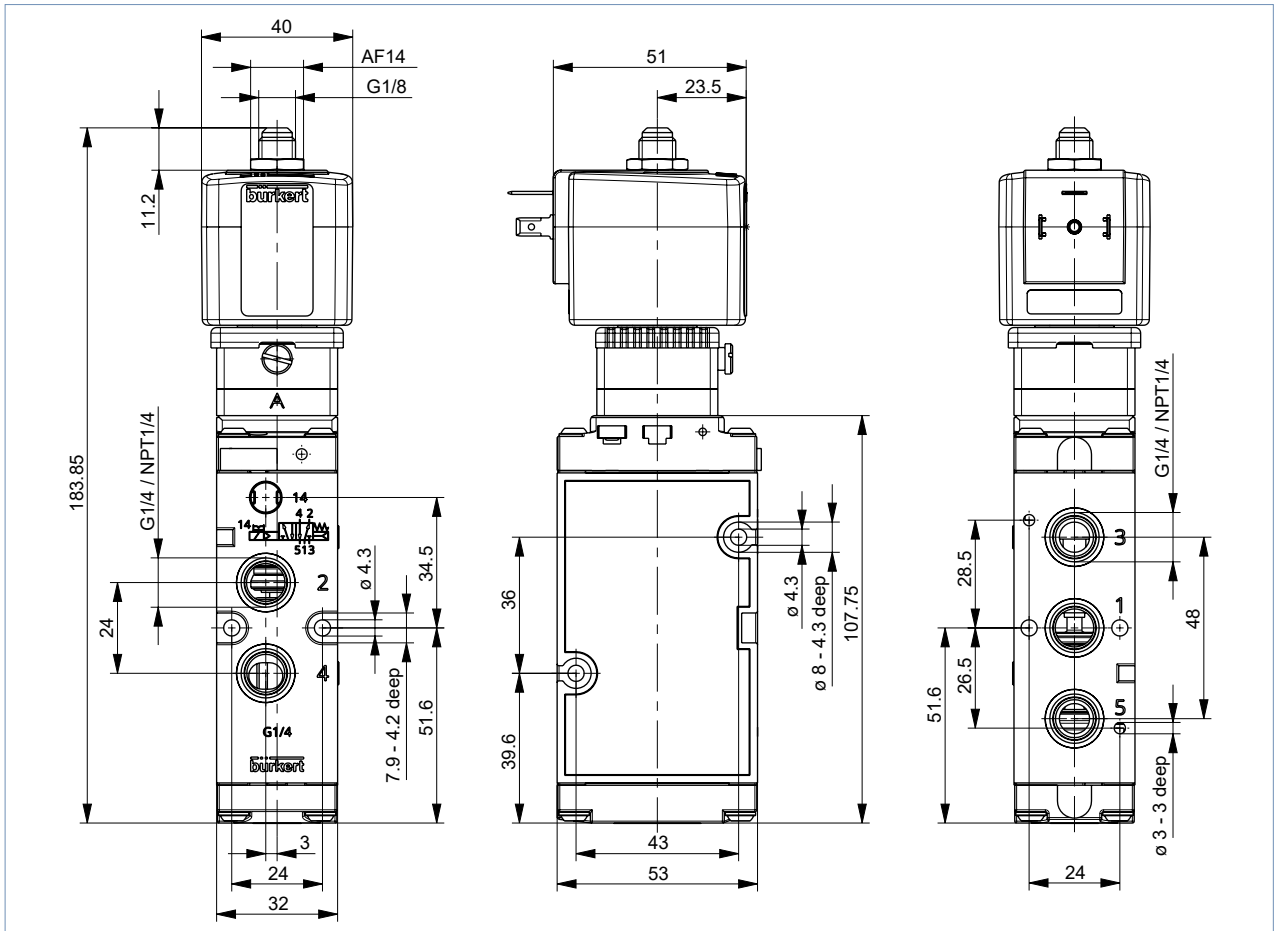

5.7. NAMUR standard version 3/2-way valve, circuit function C or 5/2-way valve, circuit function H

Note:

Dimensions in mm

With plug form B or C

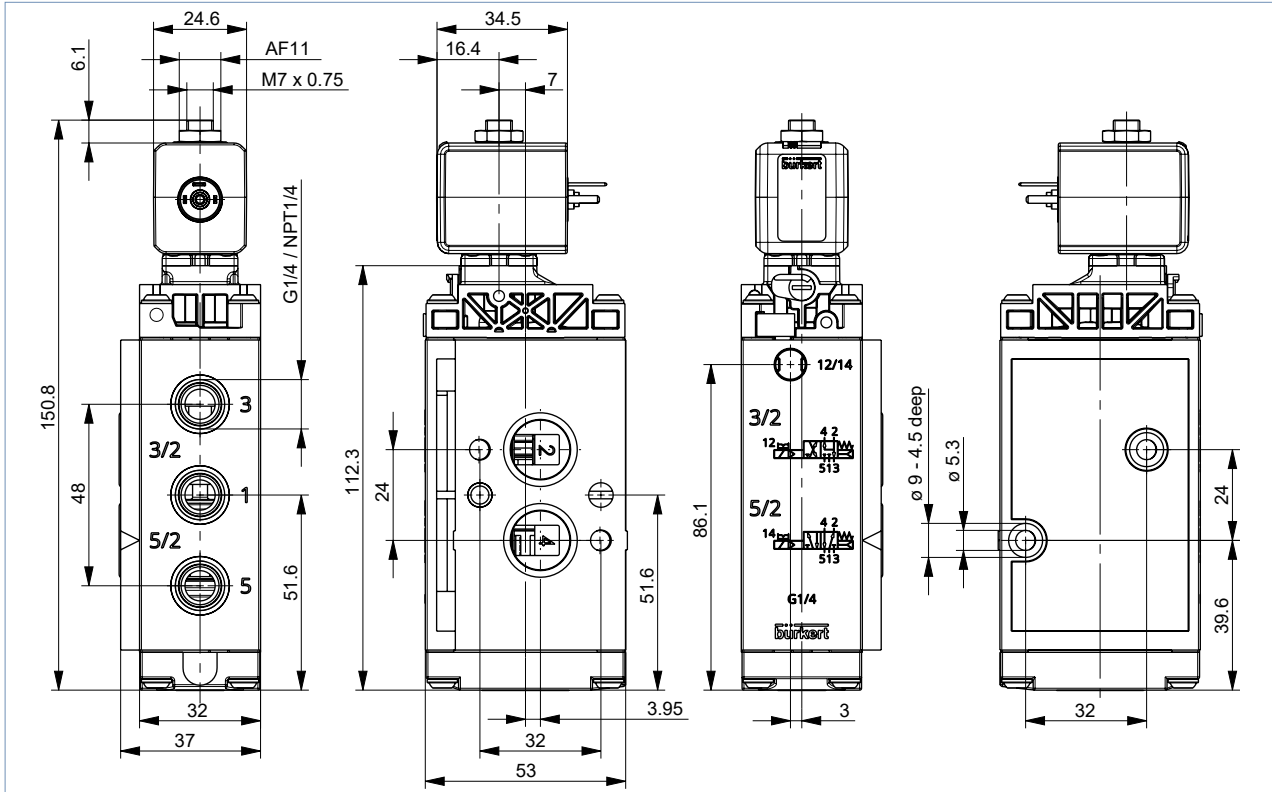

With plug form A

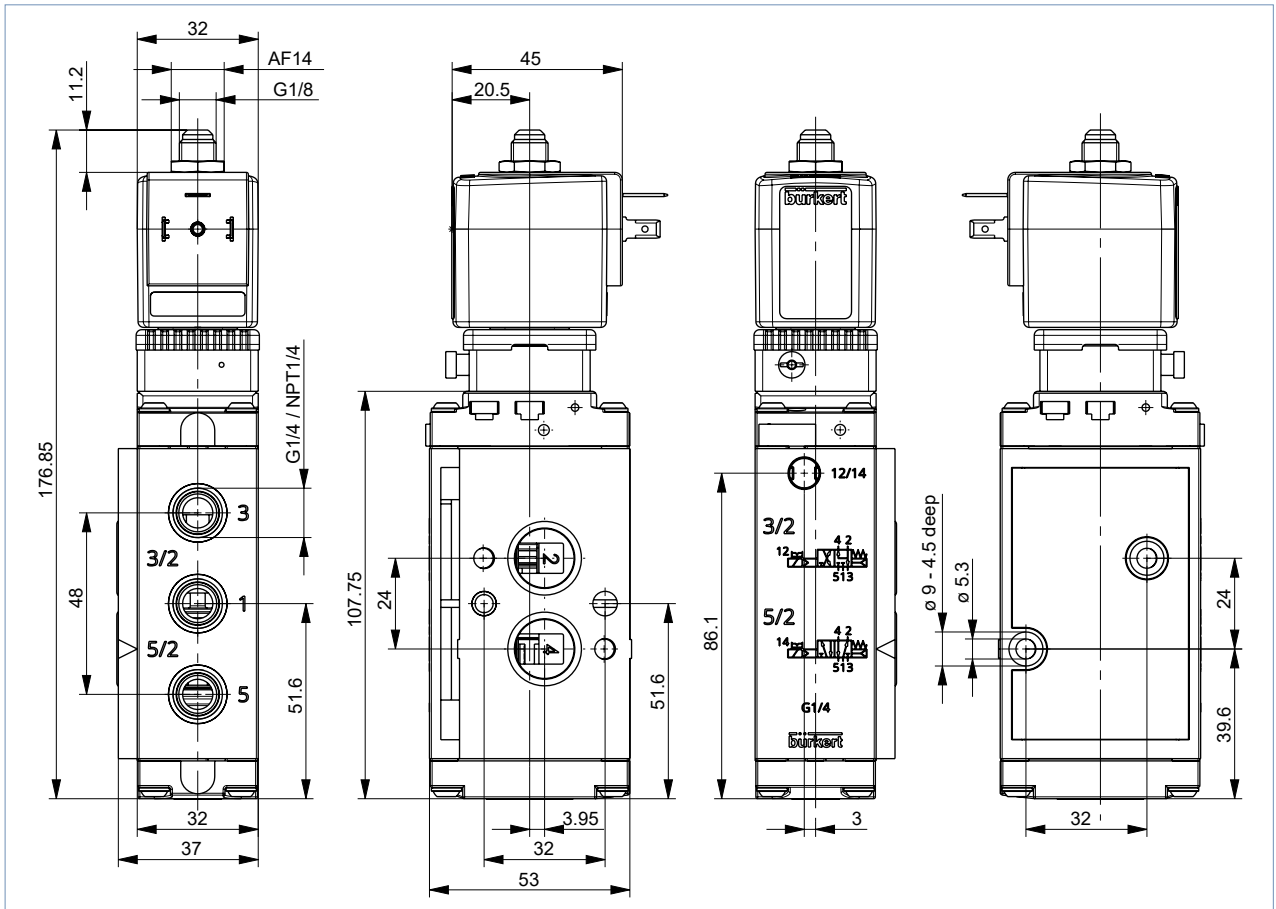

5.8. NAMUR Ex mb/eb mb version 3/2-way valve, circuit function C or 5/2-way valve, circuit function H

With moulded cable (3 m long) (Ex mb)

Note:

- Dimensions in mm
- For the coil dimensions, see chapter “5.12. ATEX version cable coil and terminal box” on page 31.

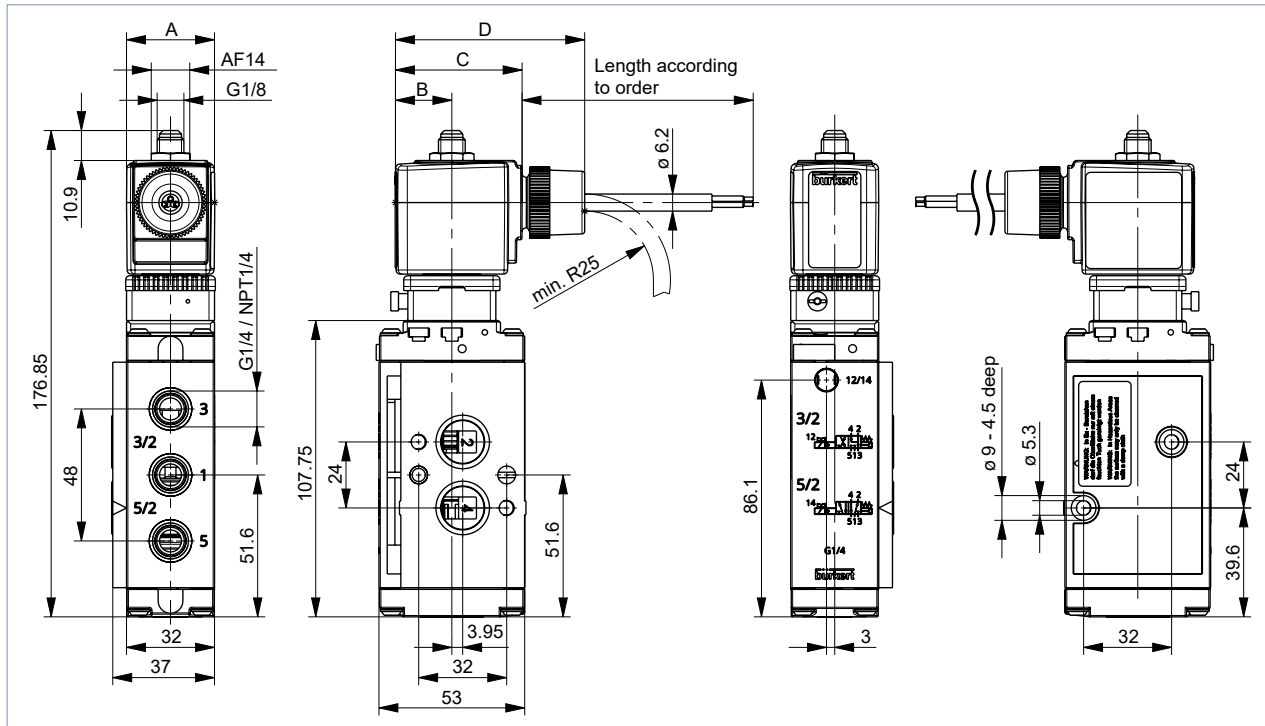

With terminal box (Ex eb mb)

Note:

- The dimensions of the housing are identical to the version with molded cable.
- For the coil dimensions, see chapter “5.12. ATEX version cable coil and terminal box” on page 31.

5.9. NAMUR Ex ia version 3/2-way valve, circuit function C or 5/2-way valve, circuit function H

Note:

Dimensions in mm

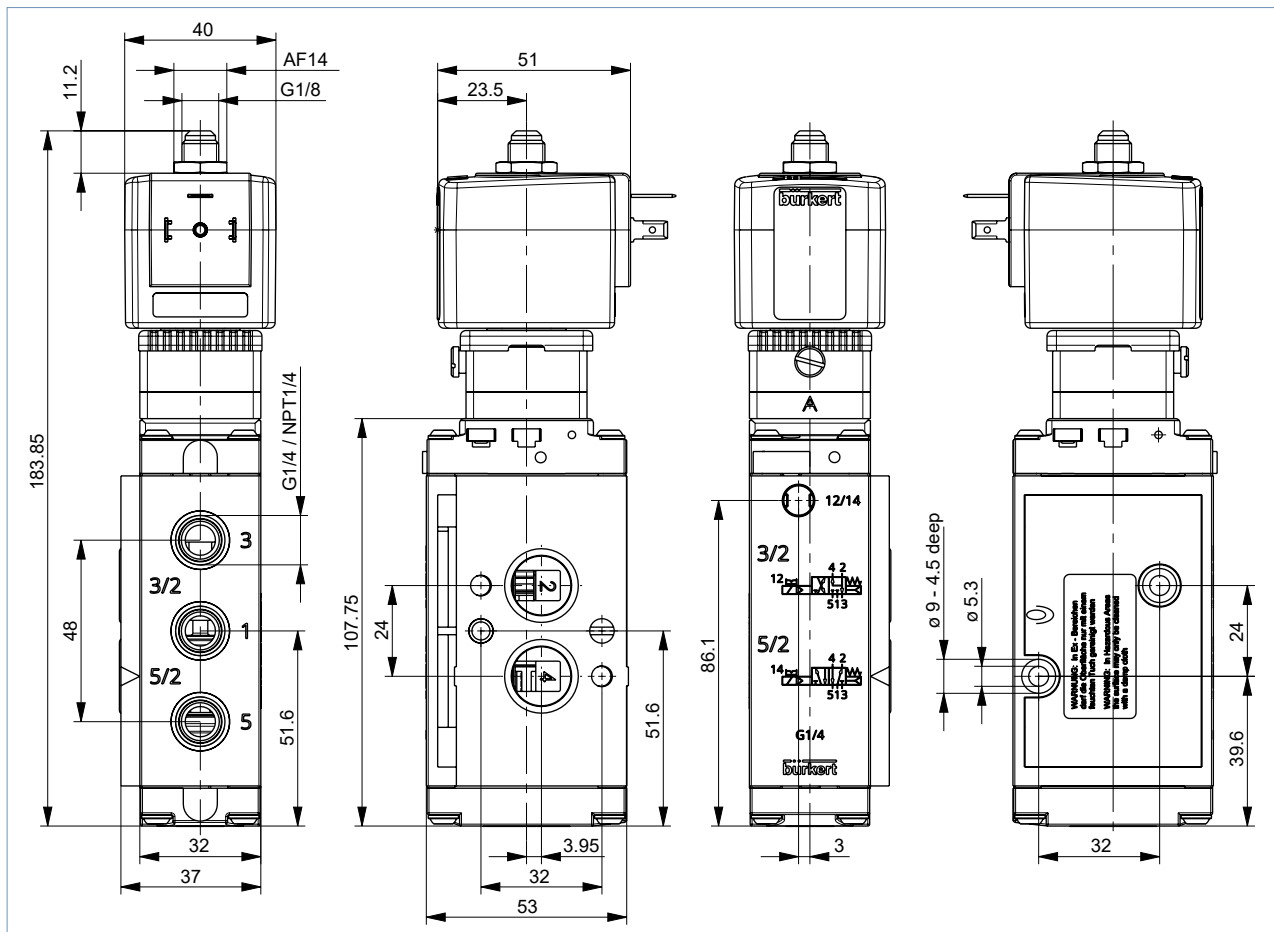

DTS 1000011067 EN Version: U Status: RL (released | freigegeben | valide) printed: 11.07.2023

5.10. Standard, Ex mb, Ex eb mb and Ex ia version or extended temperature range, circuit function H, L, N, Z (Impulse)

Note:
Dimensions in mm

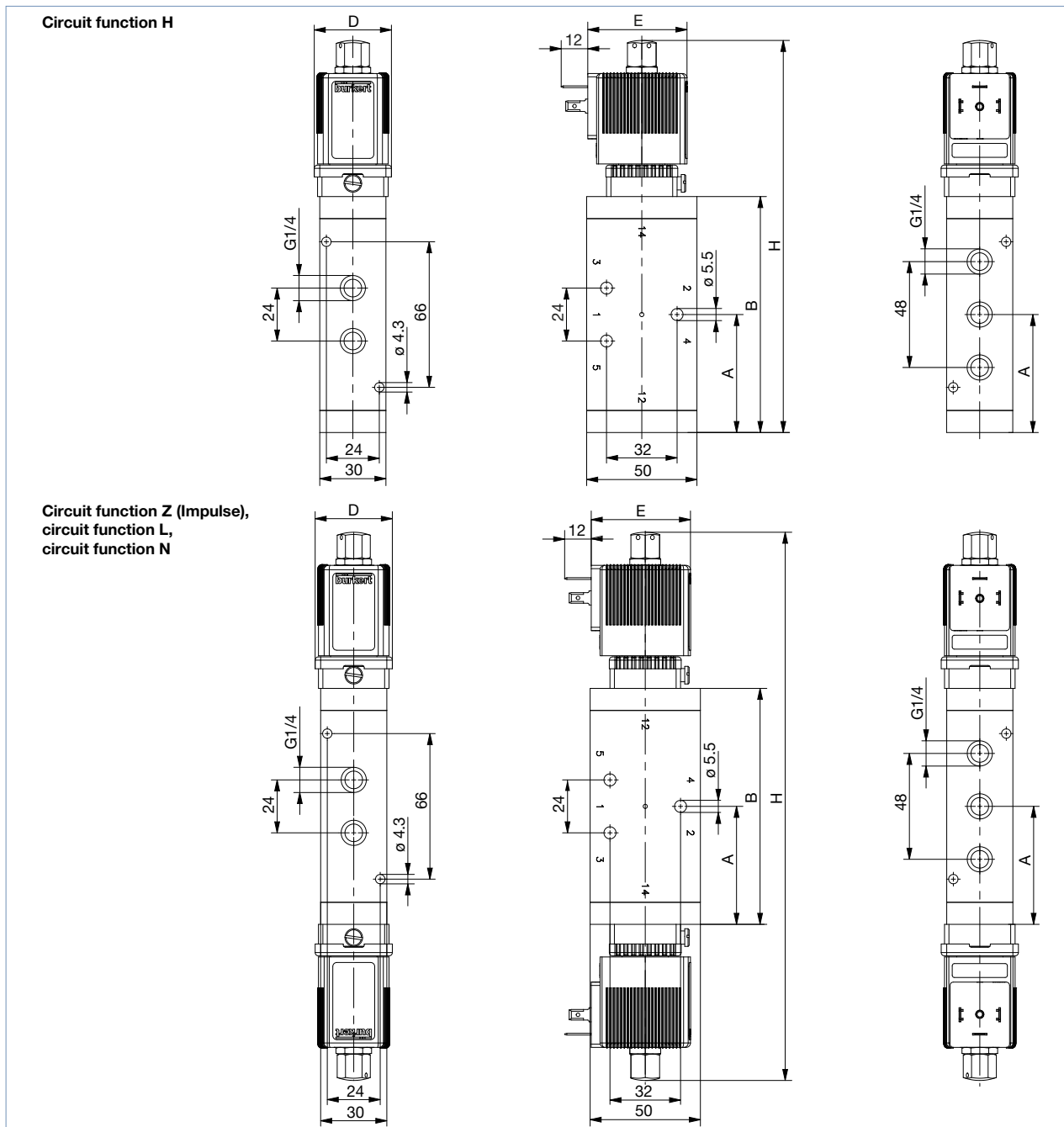

Version	Variant	A	B	D			E			H	
				Standard, Ex mb, Ex eb mb ^{1.)}	Ex ia	Standard, Ex mb, Ex eb mb ^{1.)}	Ex ia	Standard, Ex mb, Ex eb mb ^{1.)}	Ex ia		
H	Stainless steel	53.5	107	35	40.7	45	51	177.8	186.6		
H	Aluminium	43.5	97	35	40.7	45	51	167.8	176.6		
Z (Impulse), L, N	Stainless steel	53.5	107	35	40.7	45	51	248.6	266.2		
Z (Impulse), L, N	Aluminium	53.5	107	35	40.7	45	51	148.6	266.2		

1.) For Ex eb mb coil dimensions see chapter "5.12. ATEX version cable coil and terminal box" on page 31.

5.11. NAMUR Standard, Ex mb, Ex ebmb and -Ex ia version for extended temperature range, circuit function C, H, L, N, Z (Impulse)

Note:
Dimensions in mm

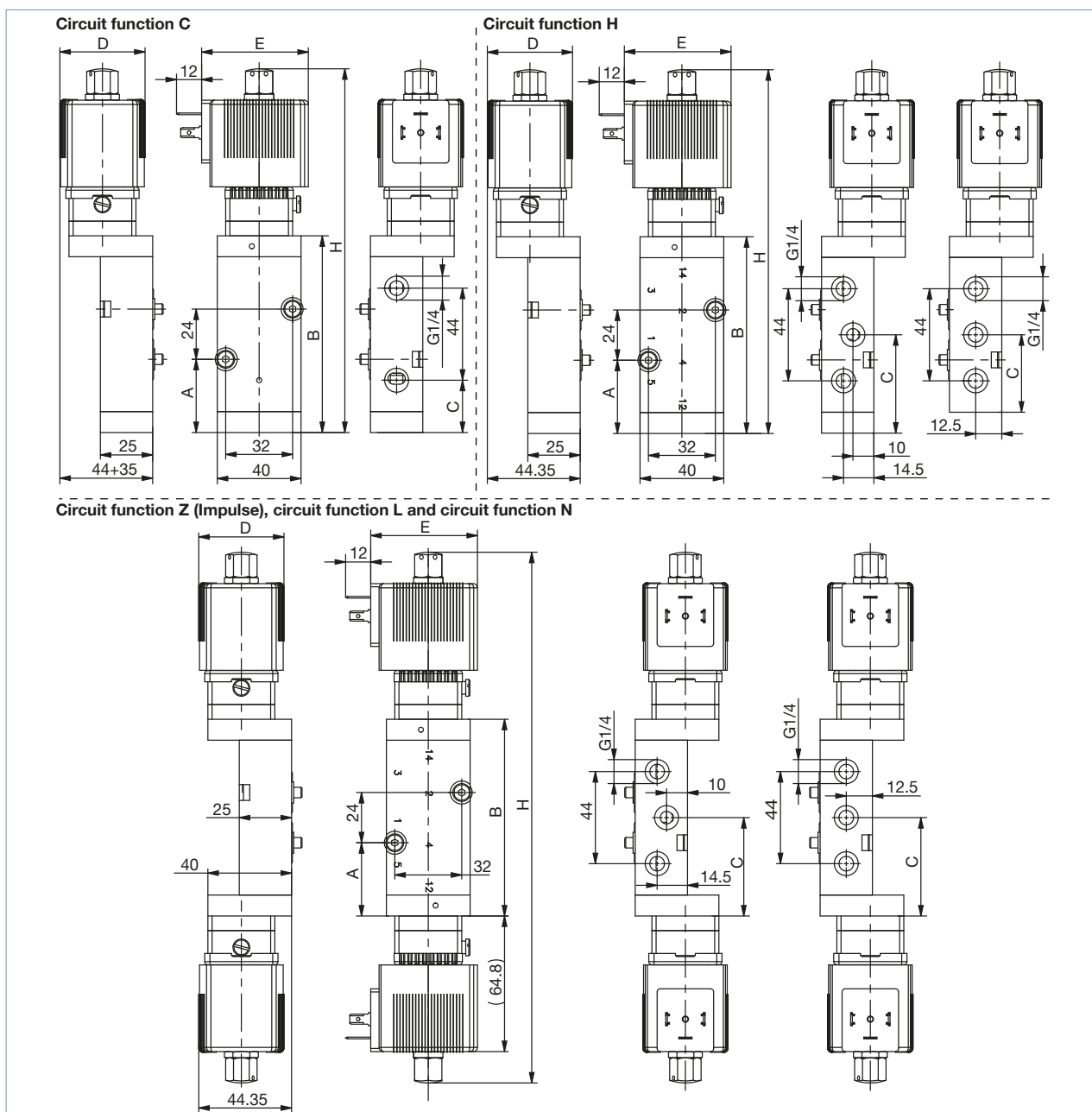

Version	Variant	A	B	C	D		E		H	
					Standard, Ex mb, Ex eb mb ^{1.)}	Ex ia	Standard, Ex mb, Ex eb mb ^{1.)}	Ex ia	Standard, Ex mb, Ex eb mb ^{1.)}	Ex ia
C	Stainless steel	35	94	25	35	40.7	45	51	165	173.8
C	Aluminium	25	84	15	35	40.7	45	51	155	163.8
H	Stainless steel	35	94	47	35	40.7	45	51	165	173.8
H	Aluminium	25	84	37	35	40.7	45	51	155	163.8
Z (Impulse), L, N	Stainless steel	35	94	47	35	40.7	45	51	236	253.6
Z (Impulse), L, N	Aluminium	35	94	47	35	40.7	45	51	236	253.6

1.) For Ex eb mb coil dimensions see chapter "5.12. ATEX version cable coil and terminal box" on page 31.

DTS 1000011067 EN Version: U Status: RL (released | freigegeben | valide) printed: 11.07.2023

5.12. ATEX version cable coil and terminal box

Note:
Dimensions in mm

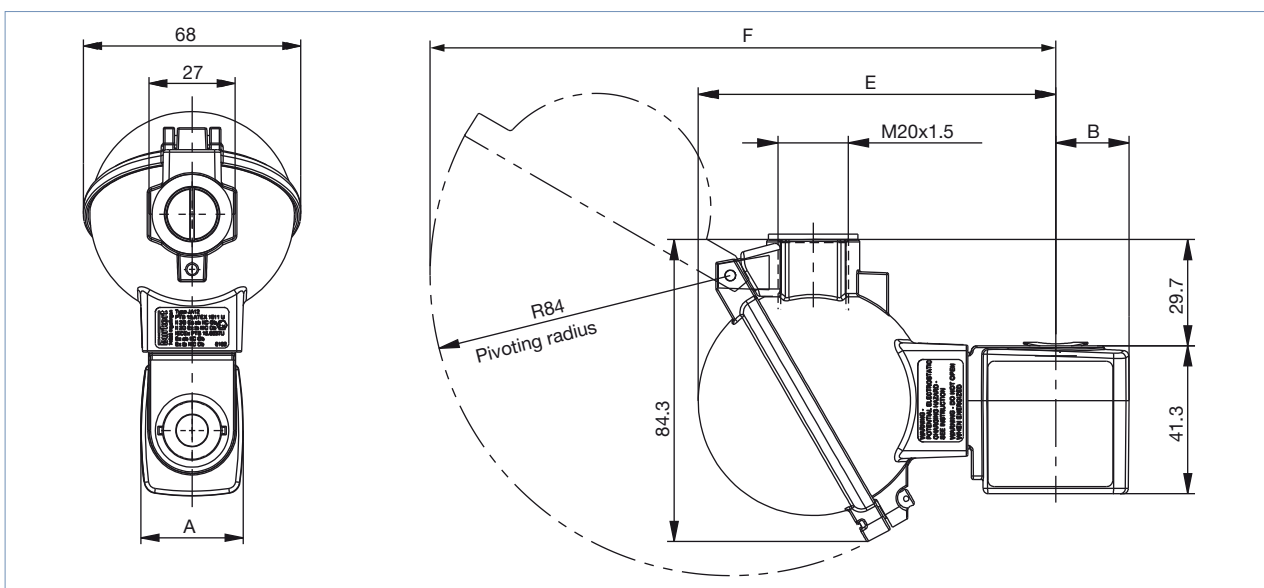
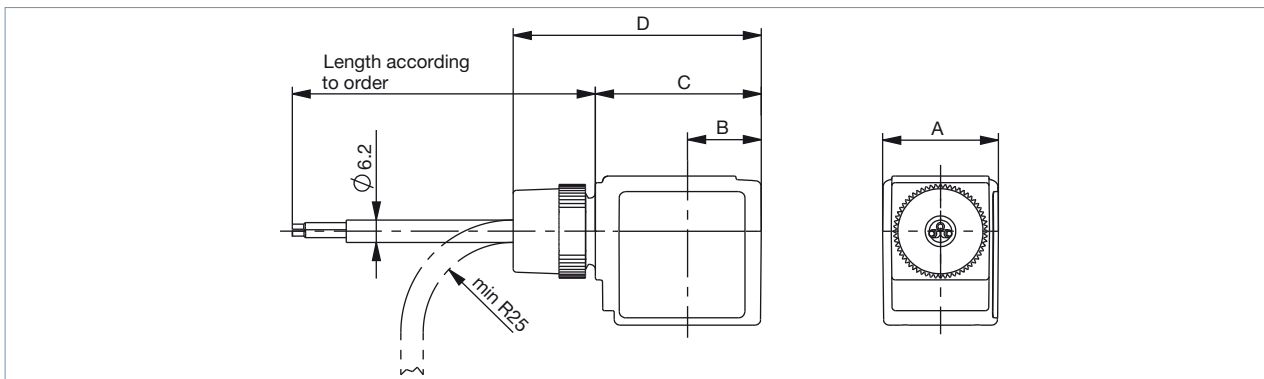

Coil size	A	B	C	D	E	F
5	32	20.5	46	66.8	99.8	174.7
6	40	23.5	52	74.8	102.8	177.7

DTS 1000011067 EN Version: U Status: RL (released | freigegeben | valide) printed: 11.07.2023

6. Product design and assembly

6.1. Block construction

Note:

Single modules or pre-mounted blocks are available.

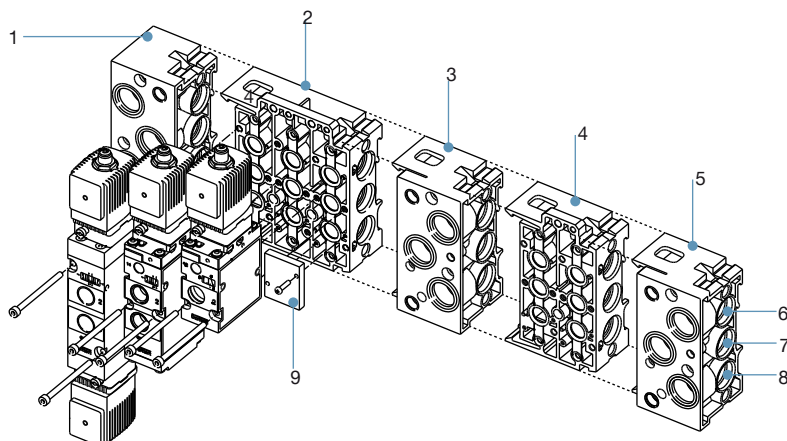

No.	Element
1	Connector module left
2	Basic module 3-fold
3	Intermediate supply module: supply channel pushed through for additional pressure supply or Connector module, right: supply channel closed off, there by several operational pressures possible in a single block
4	Basic module 2-fold
5	Connector module right
6	Supply port: 3(R)
7	Supply port: 1(P)
8	Supply port: 5(S)
9	Covering plate for 3/2-way valve (to cover unused connections)

Note:

Valves with NAMUR flange, with Ex ia coil or Ex versions with terminal boxes are not suitable for block mounting.

Ordering example Type 6519 with pneumatic module Type MP07		
Unit	Version	Article no.
1	Connector module right, G ½	635331
1	Intermediate supply module	637505
1	Basic module 2-fold universal (for 3/2-, 5/2- and 5/3-way)	635319
1	Basic module 3-fold universal (for 3/2-, 5/2- and 5/3-way)	635343
5	Connector module left, G ½	635324

Version	Article no.
Connector module right, G ½	635331
Intermediate supply module	637505
Basic module 2-fold universal (for 3/2-, 5/2- and 5/3-way)	635319
Basic module 3-fold universal (for 3/2-, 5/2- and 5/3-way)	635343
Connector module left, G ½	635324
Covering plate for 5/2-way and 5/3-way (to cover unused valve positions)	635335
Covering plate for 3/2-way (to cover unused connections)	635337



DTS 1000011067 EN Version: U Status: RL (released | freigegeben | valide) printed: 11.07.2023

7. Product accessories

7.1. Cable glands for ATEX/IECEX terminal box

Note:

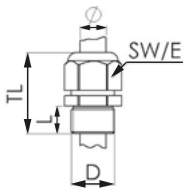
A cable gland in polyamide version is included in the delivery. A nickel-plated brass version can be ordered at a surcharge, see “Cable glands for ATEX/IECEX terminal box” on page 59.

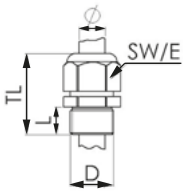
Description	Ex approvals		Dimensions										
	Certification	Identification											
Ex cable gland, Brass, nickel-plated, 6...13 mm 	PTB 04 ATEX 1112 X, IECEX PTB 13.0027X	II 2 G Ex e IIC Gb, II 2 D Ex tb IIIC Db IP68	 <table border="1"> <tr><td>TL</td><td>29...37 mm</td></tr> <tr><td>L</td><td>6 mm</td></tr> <tr><td>D</td><td>20 mm</td></tr> <tr><td>SW</td><td>24 mm</td></tr> <tr><td>E</td><td>27 mm</td></tr> </table>	TL	29...37 mm	L	6 mm	D	20 mm	SW	24 mm	E	27 mm
TL	29...37 mm												
L	6 mm												
D	20 mm												
SW	24 mm												
E	27 mm												
Ex cable gland, Polyamide, 7...13 mm 	PTB 13 ATEX 1015 X, IECEX PTB 13.0034X	II 2 G Ex e IIC Gb, II 2 D Ex tb IIIC Db IP68	 <table border="1"> <tr><td>TL</td><td>36...45 mm</td></tr> <tr><td>L</td><td>10 mm</td></tr> <tr><td>D</td><td>20 mm</td></tr> <tr><td>SW</td><td>24 mm</td></tr> <tr><td>E</td><td>28 mm</td></tr> </table>	TL	36...45 mm	L	10 mm	D	20 mm	SW	24 mm	E	28 mm
TL	36...45 mm												
L	10 mm												
D	20 mm												
SW	24 mm												
E	28 mm												

7.2. Special tool to turn the terminal box

Note:

This special tool is not supplied with the valve, see “Cable glands for ATEX/IECEX terminal box” on page 59.

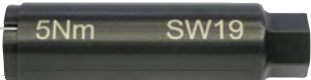
Description	Components of the set
Set SC02-AC10 	<ul style="list-style-type: none"> • Special wrench • Service manual

8. Ordering information

8.1. Bürkert eShop – Easy ordering and quick delivery



Bürkert eShop

You want to find your desired Bürkert product or spare part quickly and order directly? Our online shop is available for you 24/7. Sign up and enjoy all the benefits.

Order online now

DTS 1000011067 EN Version: U Status: RL (released | freigegeben | valide) printed: 11.07.2023

8.2. Bürkert product filter



Bürkert product filter – Get quickly to the right product

You want to select products comfortably based on your technical requirements? Use the Bürkert product filter and find suitable articles for your application quickly and easily.



[Try out our product filter](#)

8.3. Ordering chart standard version

With plug form A

Note:

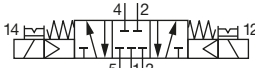
- Please note that the cable plug must be ordered separately, see [“Cable plug Type 2518, form A according to DIN EN 175301 - 803” on page 57](#) or separate data sheet for [Type 2518](#) ▶.
- Further variants without manual override available on request.

Circuit function	Orifice	Seal material body	Q _{Nn} val-ue air ¹⁾ [l/min]	Pressure range ²⁾ [bar]	Electrical connection	Nominal power [W]	Voltage/ Frequency [V/Hz]	Article no.	
	[mm]							G¼	NPT
Brass threaded bushing, socket 1, 3 and 5 can also be flanged; without cable plug									
CF H 5/2-way solenoid valve Servo-controlled, with manual override Pressure applied via port (1), therefore one of the two ports (2) or (4) is under pressure. 	8.0	NBR and PUR (Polyamide)	1300	2...10	Form A	2	024/DC	132465	X
							024/50...60	132466	X
							110/50...60	132467	X
							230/50...60	132468	X
CF L 5/3-way solenoid valve With manual override In middle position all ports locked Normally closed 	9.0	NBR (Aluminium)	1300	3...10	Form A	2	024/DC	132469	X
							024/50...60	132470	X
							110/50...60	132471	X
							230/50...60	132472	X
CF N 5/3-way solenoid valve With manual override In middle position ports 2 and 4 exhausted 	9.0	NBR (Aluminium)	1300	3...10	Form A	2	024/DC	132473	X
							024/50...60	132474	X
							110/50...60	132475	X
							230/50...60	132476	X

1.) Measurement at 6 bar and +20 °C at valve inlet and 1 bar pressure difference
 2.) Pressure data: Overpressure to atmospheric pressure
 X: on request

DTS 1000011067 EN Version: U Status: RL (released | freigegeben | valide) printed: 11.07.2023

With plug form B

Note:

- Please note that the cable plug must be ordered separately, see “[Cable plug Type 2507, form B according to industry standard](#)” on [page 58](#) or separate data sheet for [Type 2507](#) ▶.
- Further variants without manual override available on request.

Circuit function	Orifice	Seal material body	Q _{Nn} value	Pressure range ²⁾	Electrical connection	Nominal power	Voltage/Frequency	Article no.	
	[mm]		[l/min]	[bar]		[W]		[V/Hz]	G¼
Brass threaded bushing, socket 1, 3 and 5 can also be flanged; without cable plug									
CF H 5/2-way solenoid valve Servo-controlled, with manual override Pressure applied via port (1), therefore one of the two ports (2) or (4) is under pressure.	8.0	NBR and PUR (Polyamide)	1300	2...10	Form B	1.7	024/DC	20064574 𐀀	20064575 𐀀
							024/50	X	X
							024/60	X	X
							110/50	X	X
							120/60	X	X
							230/50	X	X
							240/60	X	X

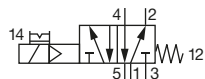

X: on request

With plug form C

Note:

- Please note that the cable plug must be ordered separately, see “[Cable plug Type 2516, form C according to DIN EN 175301-803](#)” on [page 58](#) or separate data sheet for [Type 2516](#) ▶.
- Further variants without manual override available on request.

Circuit function	Orifice	Seal material body	Q _{Nn} value	Pressure range ²⁾	Electrical connection	Nominal power	Voltage/Frequency	Article no.	
	[mm]		[l/min]	[bar]		[W]		[V/Hz]	G¼
Brass threaded bushing, socket 1, 3 and 5 can also be flanged; without cable plug									
CF H 5/2-way solenoid valve Servo-controlled, with manual override Pressure applied via port (1), therefore one of the two ports (2) or (4) is under pressure.	8.0	NBR and PUR (Polyamide)	1300	2...10	Form C	1.7	024/DC	20064570 𐀀	20064571 𐀀
							024/50	X	X
							024/60	X	X
							110/50	X	X
							120/60	X	X
							230/50	X	X
							240/60	X	X

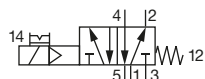

X: on request

8.4. Ordering chart Ex mb version (with moulded cable)

Note:

Further variants without manual override available on request.

Circuit function	Orifice	Seal material body	Q _{Nn} value air ¹⁾	Pressure range ²⁾	Nominal power	Voltage/Frequency	Article no.	
	[mm]						[l/min]	[bar]
Brass threaded bushing, socket 1, 3 and 5 can also be flanged; with moulded cable, 3 m long³⁾								
CF H 5/2-way solenoid valve Servo-controlled, with manual override Pressure applied via port (1), therefore one of the two ports (2) or (4) is under pressure.	8.0	NBR and PUR (Polyamide)	1300	2...10	3	024/UC	350457	X
						110/UC	350460	X
						230/UC	350461	X
CF L 5/3-way solenoid valve With manual override In middle position all ports locked Normally closed	9.0	NBR (Aluminium)	1300	3...10	3	024/UC	350470	X
						110/UC	X	X
						230/UC	X	X
CF N 5/3-way solenoid valve With manual override In middle position ports 2 and 4 exhausted	9.0	NBR (Aluminium)	1300	3...10	3	024/UC	350471	X
						110/UC	X	X
						230/UC	X	X

1.) Measurement at 6 bar and +20 °C at valve inlet and 1 bar pressure difference

2.) Pressure data: Overpressure to atmospheric pressure

3.) Circuit function H (5/2-way) as impulse version on request

X: on request

8.5. Ordering chart Ex eb mb version (with terminal box)

Note:

Further variants without manual override available on request.

Circuit function	Orifice	Seal material body	Q _{Nn} value air ¹⁾	Pressure range ²⁾	Nominal power	Voltage/Frequency	Article no.	
	[mm]						[l/min]	[bar]
Brass threaded bushing, socket 1, 3 and 5 can also be flanged; with terminal box without fuse								
CF H 5/2-way solenoid valve Servo-controlled, with manual override Pressure applied via port (1), therefore one of the two ports (2) or (4) is under pressure.	8.0	NBR and PUR (Polyamide)	1300	2...10	3	024/UC	350458 ☒	X
						110/UC	370160 ☒	X
						230/UC	350462 ☒	X
CF L 5/3-way solenoid valve With manual override In middle position all ports locked Normally closed	9.0	NBR (Aluminium)	1300	3...10	3	024/UC	X	X
						110/UC	X	X
						230/UC	X	X
CF N 5/3-way solenoid valve With manual override In middle position ports 2 and 4 exhausted	9.0	NBR (Aluminium)	1300	3...10	3	024/UC	X	X
						110/UC	X	X
						230/UC	X	X

1.) Measurement at 6 bar and +20 °C at valve inlet and 1 bar pressure difference

2.) Pressure data: Overpressure to atmospheric pressure

X: on request

8.6. Ordering chart Ex ia version

Note:

- Please note that the cable plug must be ordered separately, see [“Cable plug Type 2518, form A according to DIN EN 175301 - 803” on page 57](#) or separate data sheet for **Type 2518** ▶.
- Further variants with manual override available on request.

Circuit function	Orifice	Seal material body	Q _{in} value	Pressure range ²⁾	Electrical connection	Body material pilot valve	Material threaded bushing	Article no.	
	[mm]		[l/min]	[bar]				G¼	NPT
Socket 1 and 3 can also be flanged; without cable plug									
CF H 5/2-way solenoid valve Servo-controlled Pressure applied via port (1), therefore one of the two ports (2) or (4) is under pressure.	8.0	NBR and PUR (Polyamide)	1300	2...10	Form A	Stainless steel 1.4305	Stainless steel	20000912	20005551
							Brass nickel plated	20000925	X

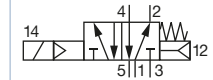

1.) Measurement at 6 bar and +20 °C at valve inlet and 1 bar pressure difference
 2.) Pressure data: Overpressure to atmospheric pressure
 X: on request

DTS 1000011067 EN Version: U Status: RL (released | freigegeben | validé) printed: 11.07.2023

8.7. Ordering chart NAMUR standard version

With plug form A

Note:

- Please note that the cable plug must be ordered separately, see [“Cable plug Type 2518, form A according to DIN EN 175301-803” on page 57](#) or separate data sheet for **Type 2518** ▶.
- Further variants with manual override available on request
- All the valves listed in the table can be used both in circuit function C and circuit function H. The units are supplied with a so-called “changeover plate”, which then enables use in both modes of operation.

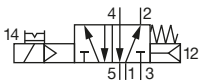
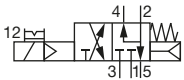
Circuit function	Orifice	Seal material body	Material connection sockets	Q _{Nn} value	Pressure range ^{3.)}	Electrical connection	Electrical nominal power	Voltage/Frequency	Article no.	
	[mm]			[l/min]	[bar]				[W]	[V/Hz]
Socket 1, 3 and 5 can also be flanged; without cable plug										
CF W 5/2- or 3/2-way solenoid valve With manual override With changeover plate	6.0	NBR and PUR	Stainless steel	900	2...10	Form A	2	024/DC	131425	X
								024/50...60	131426	X
								110/50...60	131427	X
								230/50...60	131428	X
5/2-way: Pressurisation via port (1). Therefore one of the two ports (2) or (4) is under pressure. 	6.0	NBR and PUR	Brass nickel plated	900	2...10	Form A	2	024/DC	131421	X
								024/50...60	131422	X
								110/50...60	131423	X
								230/50...60	131424	X
3/2-way: Pressurisation via port (1), normally closed 										

1.) When the connecting sockets are made of stainless steel, then the mounting screws are also made of stainless steel.

2.) Measurement at 6 bar and +20 °C at valve inlet and 1 bar pressure difference



3.) Pressure data: Overpressure to atmospheric pressure

X: on request

With plug form B

Note:

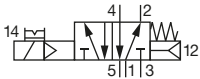
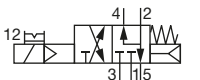
- Please note that the cable plug must be ordered separately, see “[Cable plug Type 2507, form B according to industry standard](#)” on [page 58](#) or separate data sheet for [Type 2507](#) ▶.
- Further variants with manual override available on request
- All the valves listed in the table can be used both in circuit function C and circuit function H. The units are supplied with a so-called “changeover plate”, which then enables use in both modes of operation.

Circuit function	Orifice	Seal material body	Material connection sockets	Q _{Nn} value	Pressure range ^{3.)}	Electrical connection	Electrical nominal power	Voltage/Frequency	Article no.		
	[mm]			[l/min]	[bar]				[W]	[V/Hz]	G¼
Socket 1, 3 and 5 can also be flanged; without cable plug											
CF W 5/2- or 3/2-way solenoid valve With manual override With changeover plate 5/2-way: Pressurisation via port (1). Therefore one of the two ports (2) or (4) is under pressure.  3/2-way: Pressurisation via port (1), normally closed 	6.0	NBR and PUR	Stainless steel	900	2...10	Form B	1.7	024/DC	X	X	
								024/50...60	X	X	
								110/50...60	X	X	
								230/50...60	X	X	
		6.0	NBR and PUR	Brass nickel plated	900	2...10	Form B	1.7	024/DC	20048921 	X
									024/50	X	X
									024/60	X	X
									110/50	X	X
									120/60	X	20048924 
									230/50	X	X
								240/60	X	X	

1.) When the connecting sockets are made of stainless steel, then the mounting screws are also made of stainless steel.

2.) Measurement at 6 bar and +20 °C at valve inlet and 1 bar pressure difference

3.) Pressure data: Overpressure to atmospheric pressure

X: on request

With plug form C

Note:

- Please note that the cable plug must be ordered separately, see “[Cable plug Type 2516, form C according to DIN EN 175301-803](#)” on page 58 or separate data sheet for [Type 2516](#) ▶.
- Further variants with manual override available on request
- All the valves listed in the table can be used both in circuit function C and circuit function H. The units are supplied with a so-called “changeover plate”, which then enables use in both modes of operation.

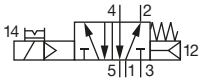
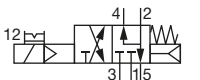
Circuit function	Orifice	Seal material body	Material connection sockets	Q _{Nn} value	Pressure range ^{3.)}	Electrical connection	Electrical nominal power	Voltage/Frequency	Article no.		
	[mm]			[l/min]	[bar]				G¼	NPT	
Socket 1, 3 and 5 can also be flanged; without cable plug											
CF W 5/2- or 3/2-way solenoid valve With manual override With changeover plate 5/2-way: Pressurisation via port (1). Therefore one of the two ports (2) or (4) is under pressure.  3/2-way: Pressurisation via port (1), normally closed 	6.0	NBR and PUR	Stainless steel	900	2...10	Form C	1.7	024/DC	X	X	
								024/50...60	X	X	
								110/50...60	X	X	
								230/50...60	X	X	
		6.0	NBR and PUR	Brass nickel plated	900	2...10	Form C	1.7	024/DC	20048920	X
									024/50	X	X
									024/60	X	X
									110/50	X	X
									120/60	X	20064576
									230/50	X	X
								240/60	X	X	

1.) When the connecting sockets are made of stainless steel, then the mounting screws are also made of stainless steel.

2.) Measurement at 6 bar and +20 °C at valve inlet and 1 bar pressure difference

3.) Pressure data: Overpressure to atmospheric pressure

X: on request

8.8. Ordering chart NAMUR Ex mb version (with moulded cable)

Note:

- Further variants with manual override available on request
- All the valves listed in the table can be used both in circuit function C and circuit function H. The units are supplied with a so-called “changeover plate”, which then enables use in both modes of operation.

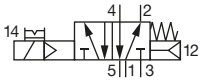
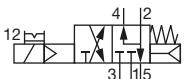
Circuit function	Orifice	Seal material body	Material connection bushing ^{1.)}	Threaded port connection	Q _{in} value air ^{2.)}	Pressure range ^{3.)}	Weight	Electrical nominal power	Voltage/Fre- quency	Article no.			
	[mm]			[inch]						[l/min]	[bar]	[g]	[W]
CF W	Version Ex mb, with moulded 3 m cable												
5/2- or 3/2-way solenoid valve With manual override With changeover plate 5/2-way: Pressurisation via port (1). Therefore one of the two ports (2) or (4) is under pressure.  3/2-way: Pressurisation via port (1), normally closed 	6.0	NBR and PUR	Stainless steel	G ¼	900	2...10	650	3	024/UC	350476	X		
											110/UC	350483	X
											230/UC	350486	X
					Brass nickel plated	G ¼	900	2...10	650	3	024/UC	350474	X
											110/UC	350484	X
											230/UC	350487	X

1.) When the connecting sockets are made of stainless steel, then the mounting screws are also made of stainless steel.

2.) Measurement at 6 bar and +20 °C at valve inlet and 1 bar pressure difference

3.) Pressure data: Overpressure to atmospheric pressure

X: on request

DTS 1000011067 EN Version: U Status: RL (released | freigegeben | valide) printed: 11.07.2023

8.9. Ordering chart NAMUR Ex eb mb version (with terminal box)

Note:

- Further variants with manual override available on request
- All the valves listed in the table can be used both in circuit function C and circuit function H. The units are supplied with a so-called “changeover plate”, which then enables use in both modes of operation.

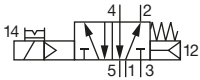
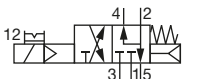
Circuit function	Orifice	Seal material body	Material connection bushing ^{1.)}	Threaded port connection	Q _{in} value air ^{2.)}	Pressure range ^{3.)}	Weight	Electrical nominal power	Voltage/Fre- quency	Article no.					
	[mm]			[inch]						[l/min]	[bar]	[g]	[W]	[V/Hz]	G¼
CF W	Version Ex eb mb, with terminal box without fuse														
5/2- or 3/2-way solenoid valve With manual override With changeover plate 5/2-way: Pressurisation via port (1). Therefore one of the two ports (2) or (4) is under pressure.  3/2-way: Pressurisation via port (1), normally closed 	6.0	NBR and PUR	Stainless steel	G ¼	900	2...10	690	3	024/UC	350478	X				
										110/UC	X	X			
										230/UC	350489	X			
						Brass nickel plated	G ¼	900	2...10	690	3	024/UC	350477	X	
													110/UC	350485	X
													230/UC	350488	X

1.) When the connecting sockets are made of stainless steel, then the mounting screws are also made of stainless steel.
 2.) Measurement at 6 bar and +20 °C at valve inlet and 1 bar pressure difference
 3.) Pressure data: Overpressure to atmospheric pressure
 X: on request

DTS 1000011067 EN Version: U Status: RL (released | freigegeben | valide) printed: 11.07.2023

8.10. Ordering chart NAMUR Ex ia version

Note:

- Please note that the cable plug must be ordered separately, see **“Cable plug Type 2518, form A according to DIN EN 175301 - 803” on page 57** or separate data sheet for **Type 2518** ▶.
- Further variants with manual override available on request
- All the valves listed in the table can be used both in circuit function C and circuit function H. The units are supplied with a so-called “changeover plate”, which then enables use in both modes of operation.
- All valves have mounting plates and tag connectors acc. to DIN EN 175301 - 803 form A (previously DIN 43650) and are supplied without cable plug.

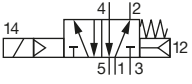
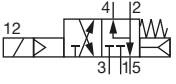
Circuit function	Orifice [mm]	Seal material body	Q _{N₀} value air ^{1.)} [l/min]	Pressure range ^{2.)} [bar]	Weight [g]	Body material pilot valve	Material threaded bushing	Article no.	
								G¼	NPT
CF W 5/2- or 3/2-way solenoid valve With changeover plate 5/2-way: Pressurisation via port (1). Therefore one of the two ports (2) or (4) is under pressure  3/2-way: Pressurisation via port (1), normally closed 	6.0	NBR and PUR (Polyamide)	900	2...10	670	Stainless steel 1.4305	Stainless steel	20000899 ☒	X
							Brass nickel plated	20000907 ☒	20000932 ☒

1.) Measurement at 6 bar and +20 °C at valve inlet and 1 bar pressure difference

2.) Pressure data: Overpressure to atmospheric pressure

X: on request











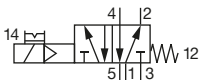



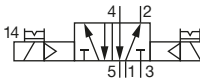

DTS 1000011067 EN Version: U Status: RL (released | freigegeben | validé) printed: 11.07.2023

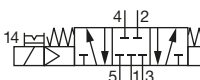
8.11. Ordering chart for extended temperature range

Standard, ematalised aluminium version

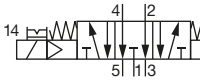
Note:

- Please note that the cable plug must be ordered separately, see “[Cable plug Type 2518, form A according to DIN EN 175301-803](#)” on page 57 or separate data sheet for **Type 2518** ▶.
- All units are supplied with a stainless steel cap nut as standard. This cap nut protects the exhaust air channel from penetrating humidity.

Circuit function	Orifice	Seal material body	Threaded port connection	Q _{Nn} value air ¹⁾	Pressure range ²⁾	Weight	Nominal power	Voltage/Frequency	Article no.
	[mm]								
Valves in aluminium with manual override									
CF H 5/2-way solenoid valve Servo-controlled, with manual override Pressure applied via port (1), therefore one of the two ports (2) or (4) is under pressure. 	9.0	FPM, NBR	G ¼	1800	2.5...10	680	2	024/DC	231386 
								024/50...60	231387 
								110/50...60	231388 
								230/50...60	231389 
CF Z 5/2-way solenoid valve Impulse version with 2 coils and manual override Pressure applied via port (1), therefore one of the two ports (2) or (4) is under pressure. 	9.0	FPM, NBR	G ¼	2100	2.5...10	990	2	024/DC	231390 
								024/50...60	231391 
								110/50...60	231392 
								230/50...60	231393 
CF L 5/3-way solenoid valve With manual override In middle position all ports locked Normally closed 	9.0	FPM, NBR	G ¼	1500	2.5...10	1060	2	024/DC	231394 
								024/50...60	231395 
								110/50...60	231396 
								230/50...60	231397 
CF N 5/3-way solenoid valve With manual override In middle position ports 2 and 4 exhausted 	9.0	FPM, NBR	G ¼	1500	2.5...10	1060	2	024/DC	231399 
								024/50...60	231400 
								110/50...60	231401 
								230/50...60	231402 

1.) Measurement at 6 bar and +20 °C at valve inlet and 1 bar pressure difference

2.) Pressure data: Overpressure to atmospheric pressure

Standard, stainless steel version

Note:

- Please note that the cable plug must be ordered separately, see **“Cable plug Type 2518, form A according to DIN EN 175301-803” on page 57** or separate data sheet for **Type 2518** ▶.
- All units are supplied with a stainless steel cap nut as standard. This cap nut protects the exhaust air channel from penetrating humidity.

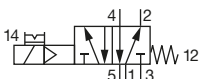
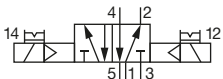
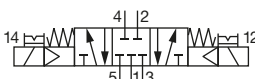
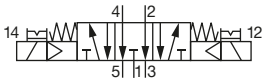
Circuit function	Orifice	Seal material body	Threaded port connection	Q _{Nn} value air ¹⁾	Pressure range ²⁾	Weight	Nominal power	Voltage/Frequency	Article no.
	[mm]		[inch]						
Valves in stainless steel with manual override									
CF H 5/2-way solenoid valve Servo-controlled, with manual override Pressure applied via port (1), therefore one of the two ports (2) or (4) is under pressure. 	9.0	PU, NBR	G ¼	1980	3...10	1370	2	024/DC	231403
								024/50...60	231404
								110/50...60	231405
								230/50...60	231406
CF Z 5/2-way solenoid valve Impulse version with 2 coils and manual override Pressure applied via port (1), therefore one of the two ports (2) or (4) is under pressure. 	9.0	PU, NBR	G ¼	1920	3...10	1680	2	024/DC	231407
								024/50...60	231408
								110/50...60	231409
								230/50...60	231410
CF L 5/3-way solenoid valve With manual override In middle position all ports locked Normally closed 	9.0	PU, NBR	G ¼	1770	3...10	1680	2	024/DC	231411
								024/50...60	231412
								110/50...60	231413
								230/50...60	231414
CF N 5/3-way solenoid valve With manual override In middle position ports 2 and 4 exhausted 	9.0	PU, NBR	G ¼	1770	3...10	1680	2	024/DC	231415
								024/50...60	231416
								110/50...60	231417
								230/50...60	231418

1.) Measurement at 6 bar and +20 °C at valve inlet and 1 bar pressure difference
 2.) Pressure data: Overpressure to atmospheric pressure

DTS 1000011067 EN Version: U Status: RL (released | freigegeben | valide) printed: 11.07.2023

8.12. Ordering chart Ex mb version for extended temperature range

Ematalised aluminium version

Note:

- Please note that the cable plug must be ordered separately, see “[Cable plug Type 2518, form A according to DIN EN 175301-803](#)” on page 57 or separate data sheet for [Type 2518](#) ▶.
- All units are supplied with a stainless steel cap nut as standard. This cap nut protects the exhaust air channel from penetrating humidity.

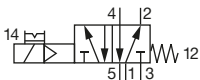
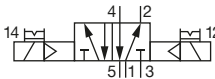
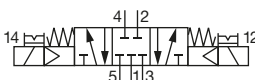
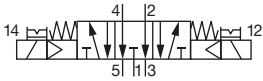
Circuit function	Orifice	Seal material body	Threaded port connection	Q _{Nn} value air ¹⁾	Pressure range ²⁾	Weight	Nominal power	Voltage/Frequency	Article no.
	[mm]								
Valves in aluminium with manual override, with moulded 3 m cable¹⁾									
CF H 5/2-way solenoid valve Servo-controlled, with manual override Pressure applied via port (1), therefore one of the two ports (2) or (4) is under pressure. 	9.0	FPM, NBR	G ¼	1800	2.5...10	680	2	024/UC	350466 𐀀
								110/UC	X
								230/UC	350468 𐀀
CF Z 5/2-way solenoid valve Impulse version with 2 coils and manual override Pressure applied via port (1), therefore one of the two ports (2) or (4) is under pressure. 	9.0	FPM, NBR	G ¼	2100	2.5...10	990	2	024/DC	350500 𐀀
								024/50...60	X
								110/50...60	X
CF L 5/3-way solenoid valve With manual override In middle position all ports locked Normally closed 	9.0	FPM, NBR	G ¼	1500	2.5...10	1060	2	024/DC	X
								024/50...60	X
								110/50...60	X
CF N 5/3-way solenoid valve With manual override In middle position ports 2 and 4 exhausted 	9.0	FPM, NBR	G ¼	1500	2.5...10	1060	2	024/DC	350472 𐀀
								024/50...60	X
								110/50...60	X

1.) Measurement at 6 bar and +20 °C at valve inlet and 1 bar pressure difference

2.) Pressure data: Overpressure to atmospheric pressure

X: on request

Stainless steel version

Note:

- Please note that the cable plug must be ordered separately, see **“Cable plug Type 2518, form A according to DIN EN 175301-803” on page 57** or separate data sheet for **Type 2518** ▶.
- All units are supplied with a stainless steel cap nut as standard. This cap nut protects the exhaust air channel from penetrating humidity.

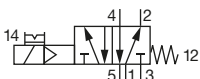
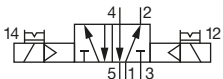
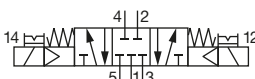
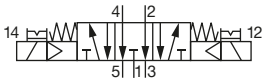
Circuit function	Orifice	Seal material body	Threaded port connection	Q _{Nn} value air ¹⁾	Pressure range ²⁾	Weight	Nominal power	Voltage/Frequency	Article no.
	[mm]		[inch]	[l/min]	[bar]			[g]	
Valves in stainless steel with manual override, with moulded 3 m cable^{1.)}									
CF H 5/2-way solenoid valve Servo-controlled, with manual override Pressure applied via port (1), therefore one of the two ports (2) or (4) is under pressure. 	9.0	PU, NBR	G ¼	1980	2.5...10	1370	3	024/UC	X
								110/UC	X
								230/UC	350467 𐀀
CF Z 5/2-way solenoid valve Impulse version with 2 coils and manual override Pressure applied via port (1), therefore one of the two ports (2) or (4) is under pressure. 	9.0	PU, NBR	G ¼	1920	2.5...10	1680	3	024/UC	350499 𐀀
								110/UC	X
								230/UC	X
CF L 5/3-way solenoid valve With manual override In middle position all ports locked Normally closed 	9.0	PU, NBR	G ¼	1170	2.5...10	1680	3	024/UC	X
								110/UC	X
								230/UC	X
CF N 5/3-way solenoid valve With manual override In middle position ports 2 and 4 exhausted 	9.0	PU, NBR	G ¼	1770	2.5...10	1680	3	024/UC	X
								110/UC	X
								230/UC	X

1.) Measurement at 6 bar and +20 °C at valve inlet and 1 bar pressure difference

2.) Pressure data: Overpressure to atmospheric pressure

X: on request





DTS 1000011067 EN Version: U Status: RL (released | freigegeben | validé) printed: 11.07.2023

8.13. Ordering chart Ex ia version for extended temperature range

Ematalised aluminium version

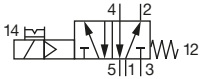
Note:

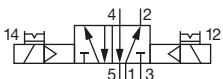
- Please note that the cable plug must be ordered separately, see “Cable plug Type 2518, form A according to DIN EN 175301-803” on page 57 or separate data sheet for Type 2518 ▶.
- All units are supplied with a stainless steel cap nut as standard. This cap nut protects the exhaust air channel from penetrating humidity.

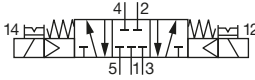
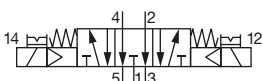
Circuit function	Orifice	Seal material body	Threaded port connection	Q _{Nn} value air ¹⁾	Pressure range ²⁾	Weight	Minimum switching current	Nominal resistance coil	Minimum terminal voltage	Article no.
	[mm]									
Valves in aluminium with manual override										
CF H 5/2-way solenoid valve Servo-controlled, with manual override Pressure applied via port (1), therefore one of the two ports (2) or (4) is under pressure. 	9.0	FPM, NBR	G ¼	1800	2.5...10	825	29	310	9	20000894 
							23	481	11	20000884 
CF Z 5/2-way solenoid valve Impulse version with 2 coils and manual override Pressure applied via port (1), therefore one of the two ports (2) or (4) is under pressure. 	9.0	FPM, NBR	G ¼	2100	2.5...10	1280	29	310	9	20000883 
							23	481	11	20000891 
CF L 5/3-way solenoid valve With manual override In middle position all ports locked Normally closed 	9.0	FPM, NBR	G ¼	1500	2.5...10	1350	29	310	9	X
							23	481	11	X
CF N 5/3-way solenoid valve With manual override In middle position ports 2 and 4 exhausted 	9.0	FPM, NBR	G ¼	1500	2.5...10	1350	29	310	9	X
							23	481	11	X

1.) Measurement at 6 bar and +20 °C at valve inlet and 1 bar pressure difference

2.) Pressure data: Overpressure to atmospheric pressure

X: on request

Stainless steel version

Note:

- Please note that the cable plug must be ordered separately, see **“Cable plug Type 2518, form A according to DIN EN 175301-803” on page 57** or separate data sheet for **Type 2518** ▶.
- All units are supplied with a stainless steel cap nut as standard. This cap nut protects the exhaust air channel from penetrating humidity.

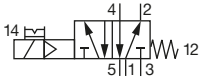
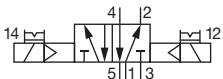
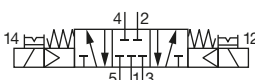
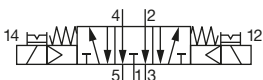
Circuit function	Orifice	Seal material body	Threaded port connection	Q _{Nn} value air ¹⁾	Pressure range ²⁾	Weight	Minimum switching current	Nominal resistance coil	Minimum terminal voltage	Article no.
	[mm]						[mA]		[V]	
Valves in stainless steel with manual override										
CF H 5/2-way solenoid valve Servo-controlled, with manual override Pressure applied via port (1), therefore one of the two ports (2) or (4) is under pressure. 	9.0	PU, NBR	G ¼	1980	3...10	1520	29	310	9	20000888
							23		11	X
CF Z 5/2-way solenoid valve Impulse version with 2 coils and manual override Pressure applied via port (1), therefore one of the two ports (2) or (4) is under pressure. 	9.0	PU, NBR	G ¼	1920	3...10	1970	29	310	9	20000889
							23		11	X
CF L 5/3-way solenoid valve With manual override In middle position all ports locked Normally closed 	9.0	PU, NBR	G ¼	1770	3...10	1970	29	310	9	X
							23		11	X
CF N 5/3-way solenoid valve With manual override In middle position ports 2 and 4 exhausted 	9.0	PU, NBR	G ¼	1770	3...10	1970	29	310	9	X
							23		11	X

1.) Measurement at 6 bar and +20 °C at valve inlet and 1 bar pressure difference

2.) Pressure data: Overpressure to atmospheric pressure

X: on request











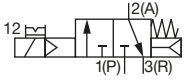

DTS 1000011067 EN Version: U Status: RL (released | freigegeben | valide) printed: 11.07.2023

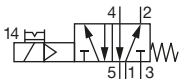
8.14. Ordering chart NAMUR standard version for extended temperature range

Ematalised aluminium version

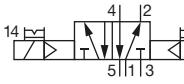
Note:

- Please note that the cable plug must be ordered separately, see “[Cable plug Type 2518, form A according to DIN EN 175301-803](#)” on page 57 or separate data sheet for [Type 2518](#) ▶.
- All units are supplied with a stainless steel cap nut as standard. This cap nut protects the exhaust air channel from penetrating humidity.

Circuit function	Orifice	Seal material body	Threaded port connection	Q _{Nn} value air ¹⁾	Pressure range ²⁾	Weight	Nominal power	Voltage/Frequency	Article no.
	[mm]								
Valves in aluminium with manual override									
CF C 3/2-way solenoid valve Servo-controlled, with manual override Normally closed 	6.0	FPM, NBR	G ¼	780	3...10	540	2	024/DC	231469 
								024/50...60	231470 
								110/50...60	231471 
								230/50...60	231472 
CF H 5/2-way solenoid valve Servo-controlled, with manual override Pressure applied via port (1), therefore one of the two ports (2) or (4) is under pressure. 	6.0	FPM, NBR	G ¼	800	3...10	540	2	024/DC	231473 
								024/50...60	231474 
								110/50...60	231475 
								230/50...60	231476 
CF Z 5/2-way solenoid valve Impulse version with 2 coils and manual override Pressure applied via port (1), therefore one of the two ports (2) or (4) is under pressure. 	6.0	FPM, NBR	G ¼	900	3...10	540	2	024/DC	231477 
								024/50...60	231478 
								110/50...60	231479 
								230/50...60	231480 

1.) Measurement at 6 bar and +20 °C at valve inlet and 1 bar pressure difference

2.) Pressure data: Overpressure to atmospheric pressure

Stainless steel version

Note:

- Please note that the cable plug must be ordered separately, see “[Cable plug Type 2518, form A according to DIN EN 175301-803](#)” on [page 57](#) or separate data sheet for [Type 2518](#) ▶.
- All units are supplied with a stainless steel cap nut as standard. This cap nut protects the exhaust air channel from penetrating humidity.

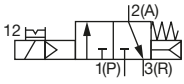
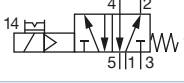
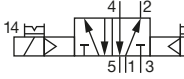
Circuit function	Orifice	Seal material body	Threaded port connection	Q _{Nn} value air ¹⁾	Pressure range ²⁾	Weight	Nominal power	Voltage/Frequency	Article no.
	[mm]		[inch]						
Valves in stainless steel with manual override									
CF C 3/2-way solenoid valve Servo-controlled, with manual override Normally closed 	6.0	PU, NBR	G ¼	1280	3...10	540	2	024/DC	231481
								024/50...60	231482
								110/50...60	231483
								230/50...60	231484
CF H 5/2-way solenoid valve Servo-controlled, with manual override Pressure applied via port (1), therefore one of the two ports (2) or (4) is under pressure. 	6.0	PU, NBR	G ¼	1060	3...10	540	2	024/DC	231485
								024/50...60	231486
								110/50...60	231487
								230/50...60	231488
CF Z 5/2-way solenoid valve Impulse version with 2 coils and manual override Pressure applied via port (1), therefore one of the two ports (2) or (4) is under pressure. 	6.0	PU, NBR	G ¼	1050	3...10	540	2	024/DC	231489
								024/50...60	231490
								110/50...60	231491
								230/50...60	231492

1.) Measurement at 6 bar and +20 °C at valve inlet and 1 bar pressure difference

2.) Pressure data: Overpressure to atmospheric pressure

8.15. Ordering chart NAMUR Ex mb version for extended temperature range

Ematalised aluminium version

Note:

- Please note that the cable plug must be ordered separately, see “[Cable plug Type 2518, form A according to DIN EN 175301-803](#)” on page 57 or separate data sheet for **Type 2518** ▶.
- All units are supplied with a stainless steel cap nut as standard. This cap nut protects the exhaust air channel from penetrating humidity.

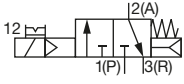
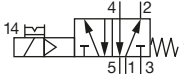
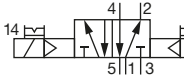
Circuit function	Orifice	Seal material body	Threaded port connection	Q _{Nn} value air ¹⁾	Pressure range ²⁾	Weight	Nominal power	Voltage/Frequency	Article no.
	[mm]								
Valves in aluminium with manual override									
CF C 3/2-way solenoid valve Servo-controlled, with manual override Normally closed 	6.0	FPM, NBR	G ¼	780	3...10	540	3	024/UC	X
								110/UC	X
								230/UC	X
CF H 5/2-way solenoid valve Servo-controlled, with manual override Pressure applied via port (1), therefore one of the two ports (2) or (4) is under pressure. 	6.0	FPM, NBR	G ¼	800	3...10	540	3	024/UC	350455 𐀀
								110/UC	X
								230/UC	X
CF Z 5/2-way solenoid valve Impulse version with 2 coils and manual override Pressure applied via port (1), therefore one of the two ports (2) or (4) is under pressure. 	6.0	FPM, NBR	G ¼	900	3...10	540	3	024/UC	350497 𐀀
								110/UC	X
								230/UC	X

1.) Measurement at 6 bar and +20 °C at valve inlet and 1 bar pressure difference

2.) Pressure data: Overpressure to atmospheric pressure

X: on request

Stainless steel version

Note:

- Please note that the cable plug must be ordered separately, see “[Cable plug Type 2518, form A according to DIN EN 175301-803](#)” on page 57 or separate data sheet for [Type 2518](#) ▶.
- All units are supplied with a stainless steel cap nut as standard. This cap nut protects the exhaust air channel from penetrating humidity.

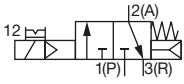
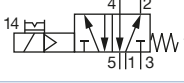
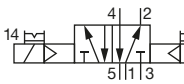
Circuit function	Orifice	Seal material body	Threaded port connection	Q _{Nn} value air ¹⁾	Pressure range ²⁾	Weight	Nominal power	Voltage/Frequency	Article no.
	[mm]		[inch]						
Valves in stainless steel with manual override									
CF C 3/2-way solenoid valve Servo-controlled, with manual override Normally closed 	6.0	PU, NBR	G ¼	1280	3...10	960	3	024/UC	X
								110/UC	X
								230/UC	X
CF H 5/2-way solenoid valve Servo-controlled, with manual override Pressure applied via port (1), therefore one of the two ports (2) or (4) is under pressure. 	6.0	PU, NBR	G ¼	1060	3...10	960	3	024/UC	X
								110/UC	X
								230/UC	X
CF Z 5/2-way solenoid valve Impulse version with 2 coils and manual override Pressure applied via port (1), therefore one of the two ports (2) or (4) is under pressure. 	6.0	PU, NBR	G ¼	1050	3...10	1260	3	024/UC	X
								110/UC	X
								230/UC	X

1.) Measurement at 6 bar and +20 °C at valve inlet and 1 bar pressure difference

2.) Pressure data: Overpressure to atmospheric pressure

X: on request

8.16. Ordering chart NAMUR Ex ia version for extended temperature range

Ematalised aluminium version

Note:

- Please note that the cable plug must be ordered separately, see [“Cable plug Type 2518, form A according to DIN EN 175301-803” on page 57](#) or separate data sheet for [Type 2518](#) ▶.
- All units are supplied with a stainless steel cap nut as standard. This cap nut protects the exhaust air channel from penetrating humidity.

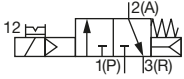
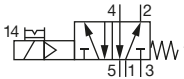
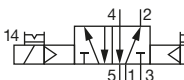
Circuit function	Orifice	Seal material body	Threaded port connection	Q _{Nn} value air ¹⁾	Pressure range ²⁾	Weight	Minimum switching current	Nominal resistance coil	Minimum terminal voltage	Article no.
	[mm]									
Valves in aluminium with manual override										
CF C 3/2-way solenoid valve Servo-controlled, with manual override Normally closed 	6.0	FPM, NBR	G ¼	780	3...10	690	29	310	9	20000896
							23	481	11	20000890
CF H 5/2-way solenoid valve Servo-controlled, with manual override Pressure applied via port (1), therefore one of the two ports (2) or (4) is under pressure. 	6.0	FPM, NBR	G ¼	800	3...10	690	29	310	9	20000882
							23	481	11	X
CF Z 5/2-way solenoid valve Impulse version with 2 coils and manual override Pressure applied via port (1), therefore one of the two ports (2) or (4) is under pressure. 	6.0	FPM, NBR	G ¼	900	3...10	1140	29	310	9	20000895
							23	481	11	20000886

1.) Measurement at 6 bar and +20 °C at valve inlet and 1 bar pressure difference

2.) Pressure data: Overpressure to atmospheric pressure

X: on request

Stainless steel version

Note:

- Please note that the cable plug must be ordered separately, see **“Cable plug Type 2518, form A according to DIN EN 175301-803” on page 57** or separate data sheet for **Type 2518** ▶.
- All units are supplied with a stainless steel cap nut as standard. This cap nut protects the exhaust air channel from penetrating humidity.

Circuit function	Orifice	Seal material body	Threaded port connection	Q _{Nn} value air ¹⁾	Pressure range ²⁾	Weight	Minimum switching current	Nominal resistance coil	Minimum terminal voltage	Article no.
	[mm]						[mA]		[V]	
Valves in stainless steel with manual override										
CF C 3/2-way solenoid valve Servo-controlled, with manual override Normally closed 	6.0	PU, NBR	G ¼	1280	3...10	1100	29	310	9	X
							23		11	X
CF H 5/2-way solenoid valve Servo-controlled, with manual override Pressure applied via port (1), therefore one of the two ports (2) or (4) is under pressure. 	6.0	PU, NBR	G ¼	1060	3...10	1100	29	310	9	X
							23		11	X
CF Z 5/2-way solenoid valve Impulse version with 2 coils and manual override Pressure applied via port (1), therefore one of the two ports (2) or (4) is under pressure. 	6.0	PU, NBR	G ¼	1050	3...10	1550	29	310	9	X
							23		11	X

1.) Measurement at 6 bar and +20 °C at valve inlet and 1 bar pressure difference

2.) Pressure data: Overpressure to atmospheric pressure

X: on request

DTS 1000011067 EN Version: U Status: RL (released | freigegeben | validé) printed: 11.07.2023

8.17. Ordering chart accessories

Cable plug Type 2518, form A according to DIN EN 175301 - 803

Note:

For further versions see data sheet [Type 2518](#) ▶.

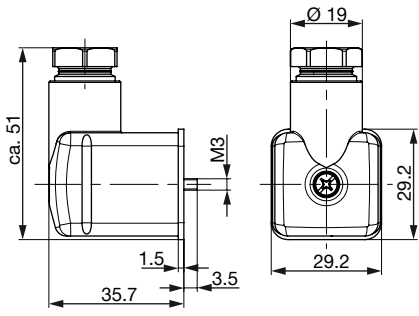
Cable plug	Dimensions	Version	Voltage	Article no.
		Without circuitry (AC/DC)	0...250 V AC/DC	314802
		With LED (AC/DC)	12...24 V AC/DC	314812
		With LED and varistor (AC/DC)	12...24 V AC/DC	314820
		With rectifier, LED and varistor	12...24 V AC/DC	314816

Cable plug Type 2513, form A according to DIN EN 175301 - 803

Note:

- Cable plug Type 2513 meets the requirements of ATEX category 3 GD when assembled with a Bürkert solenoid valve.
- For more information on the cable plug, see data sheet [Type 2513](#) ▶.

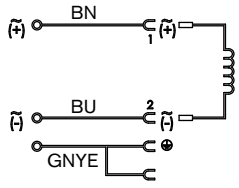
Cable plug	Circuit diagram	Cable length [mm]	Article no.
		12000	260893
		5000	260892
		3000	260891
		300	260890

Cable plug Type 2507, form B according to industry standard

Note:

- Delivery of cable plug includes a flat seal and a fixing screw.
- For further versions see data sheet **Type 2507** ▶.

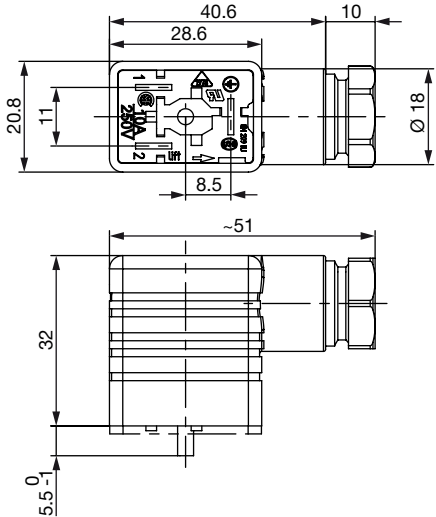
Cable plug	Dimensions	Version	Voltage	Article no.
		Without circuitry (standard)	2...250 V AC/DC	423845
		With LED	24 V AC/DC	423849
		With LED and free-wheeling diode	12...24 V AC/DC	423851
		With rectifier, LED and varistor	12...24 V AC/DC	423853

Cable plug Type 2516, form C according to DIN EN 175301 - 803

Note:

- Delivery of cable plug includes a flat seal and a fixing screw.
- For further versions see data sheet **Type 2516** ▶.

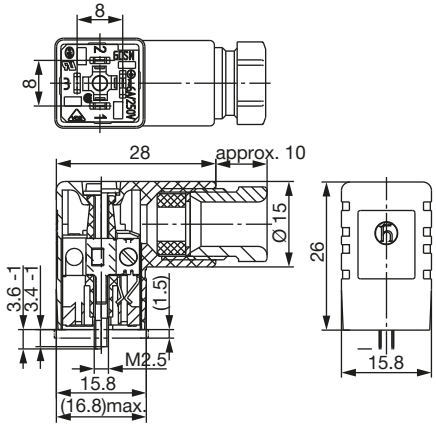
Cable plug	Dimensions	Version	Voltage	Article no.
		Without circuitry	0...250 V AC/DC	303141
		With LED	12...24 V AC/DC	303145
		With LED and varistor	12...24 V AC/DC	303148
		With rectifier, LED and varistor	12...24 V AC/DC	303142

DTS 1000011067 EN Version: U Status: RL (released | freigegeben | valide) printed: 11.07.2023

Cable glands for ATEX/IECEX terminal box

Note:

- A cable gland in polyamide version is included in the delivery. A nickel-plated brass version can be ordered at surcharge.
- For more information on Ex cable glands, see “7.1. Cable glands for ATEX/IECEX terminal box” on page 33.
- For more information on Special wrench see “7.2. Special tool to turn the terminal box” on page 33.

Description	Article no.
Ex cable gland, brass, nickel-plated, 6...13 mm ^{1.)}	773278
Ex cable gland, polyamide, 7...13 mm ^{1.)}	773277
Set SC02-AC10: special wrench ^{2.)} incl. service manual	293488

1.) Cable diameter

2.) Not included in the scope of delivery of the valve

Throttle plate for NAMUR version

With type 6519, it is possible to throttle the exhaust air at the exhaust connections R or S. This functionality reduces the travel speed of the connected actuators (process valves, cylinders, etc.). The throttling function can be achieved either by using the accessories available from Bürkert or by using commercially available throttles suitable for the process environment. In this case, the throttle is mounted on the threaded connection of the housing (connection 3; 5).

Note:

The throttle plate is installed between the actuator and the NAMUR valve.

Accessories	Description	Version	Article no.
	For regulating the supply air or exhaust air from single-acting pneumatic actuators	Throttle plate for 3/2-way NAMUR valves Anodised aluminium, NBR seal	907217
	For regulating the supply air or exhaust air from double-acting pneumatic actuators.	Throttle plate for 5/2-way NAMUR valves Anodised aluminium, NBR seal	907218

DTS 1000011067 EN Version: U Status: RL (released | freigegeben | valide) printed: 11.07.2023



Converting plate for NAMUR version

The converting plate with silencer is suitable for use with 5/2- and 5/3-way NAMUR valves as a 3/2-; 3/3-way valve. The function NC can be changed to NO by turning the converting plate by 180°.

If a throttling is required, a standard throttle must be installed at threaded connection R/5 or S/3.

Note:

The converting plate is installed between the actuator and the NAMUR valve.

Accessories	Description	Version	Article no.
	Converting plate NAMUR	Converting plate for 3/2-way NAMUR valves Anodised aluminium, NBR seal	907216 

Bürkert – Close to You

For up-to-date addresses
please visit us at
www.burkert.com

DTS 1000011067 EN Version: U Status: RL (released | freigegeben | validé) printed: 11.07.2023

Austria
Belgium
Czech Republic
Denmark
Finland
France
Germany
Italy
Netherlands

Norway
Poland
Spain
Sweden
Switzerland
Turkey
United Kingdom

