

Silencers

FESTO



Festo Core Range
Solves the majority of your automation tasks



With the Festo Core Range, we have selected the most important products and functions from our broad product catalogue, and added the quickest delivery.

Worldwide: Quickest delivery – wherever, whenever
Simply good: Expected high Festo quality
Fast: Easy and fast to select

The Core Range offers you the best value for your automation tasks.



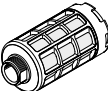

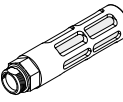
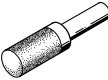
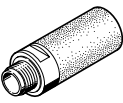
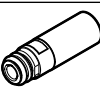
Product range overview

Design	Type	Connection D1			Push-in connector	For tubing I.D.	Push-in sleeve ∅	Noise level [dB (A)]	→ Page/ Internet	
		M thread	G thread	NPT thread						
Sintered metal										
	U	-	-	-	-	3	< 70	4		
						4			< 77	
Polymer, male thread										
	U	-	G1/8	-	-	-	-	< 74	5	
			G1/4					< 76		
			G3/8					< 82		
			G1/2					< 82		
			G3/4					< 85		
			G1					< 90		
Polymer, female thread										
	U-...-I	-	G1/8	-	-	-	-	< 76.5	6	
Die-cast metal										
	U-...-B	-	G1/8	-	-	-	-	< 74	7	
			G1/4					< 80		
			G3/8					< 80		
			G1/2					< 81		
			G3/4					< 83		
			G1					< 85		
		-		3/4 NPT	-	-	-	< 81	8	
With push-in sleeve for push-in fitting QS, Quick Star										
	UC-QS	-	-	-	-	-	3	< 60	9	
							4	< 60		
							6	< 60		
							8	< 60		
							10	< 68		
Threaded connection, for solenoid valves CPE, Compact Performance										
	UC	M5	-	-	-	-	-	< 60	10	
		M7						< 58		
		-						G1/8		< 59
								G1/4		< 60
								G3/8		< 60
Push-in connector, for solenoid valves VUVB-ST12/valve terminal type 23 VTUB-12										
	AMTC	-	-	-	Cartridge 10 mm	-	-	< 58	11	

 **Note**
Clean silencers with kerosene (not with petrol or trichloroethylene).

Product range overview

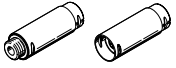
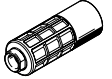
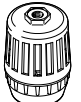
Design	Type	Connection D1			Push-in connector	For tubing I.D.	Push-in sleeve ∅	Noise level [dB (A)]	→ Page/ Internet		
		M thread	G thread	NPT thread							
Metal											
	AMTE-M-H	M5	-	-	-	-	-	< 71	12		
		-	G1/8	-	-	-	-	< 92			
		-	G1/4	-	-	-	-	< 95			
		-	G3/8	-	-	-	-	< 92			
		-	G1/2	-	-	-	-	< 92			
	AMTE-M-LH	M3	-	-	-	-	-	< 55	13		
		M5	-	-	-	-	-	< 72			
		-	G1/8	-	-	-	-	< 76			
		-	G1/4	-	-	-	-	< 83			
		-	G3/8	-	-	-	-	< 82			
		-	G1/2	-	-	-	-	< 88			
		-	G3/4	-	-	-	-	< 85			
		-	G1	-	-	-	-	< 88			
		-	-	-	10-32 UNF-2A	-	-	-		< 71	15
		-	-	-	1/8 NPT	-	-	-		< 77	
	-	-	-	1/4 NPT	-	-	-	< 82			
	-	-	-	3/8 NPT	-	-	-	< 83			
	-	-	-	1/2 NPT	-	-	-	< 85			
For vacuum generators VN-T2/T3											
	UO	M5	-	-	-	-	-	-	16		
		M7	-	-	-	-	-	-			
		-	G1/8	-	-	-	-	-			
		-	G1/4	-	-	-	-	-			
For vacuum generators VN-T4/T6											
	UOM	-	G1/4	-	-	-	-	-	17		
	UOMS	-	G3/8	-	-	-	-	-			
For soft-start/quick exhaust valve MS6-SV											
	UOS	-	G1	-	-	-	-	< 75	ms6-sv		
Filter silencer											
	LFU	-	G1/4	-	-	-	-	< 40	lfu		
		-	G3/8	-	-	-	-	-			
		-	G1/2	-	-	-	-	-			
		-	G1	-	-	-	-	-			

Datasheet – Sintered metal design

Function

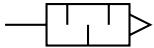

- To reduce noise and prevent contamination at the exhaust ports of pneumatic components
- Compact design



General technical data		PK-3	PK-4
Pneumatic connection		PK-3	PK-4
Mounting position		Any	
Noise level ¹⁾	[dB (A)]	< 70	< 77
Flow rate with respect to atmosphere ²⁾	[l/min]	310	580
Product weight	[g]	4.5	4.1

- 1) Measured at 0.6 MPa with respect to atmosphere at a distance of 1 m
 2) Measured at p₁ = 0.6 MPa

Operating and environmental conditions		
Operating pressure	[MPa]	0 ... 1
	[bar]	0 ... 10
	[psi]	0 ... 145
Operating medium		Compressed air to ISO 8573-1:2010 [7:-:-]
Note on the operating/pilot medium		Lubricated operation possible
Ambient temperature	[°C]	-10 ... +70

Materials	
Screwed plug	Brass
Cushioning insert	Bronze
Note on materials	RoHS-compliant
LABS (PWIS) conformity	VDMA24364-B1/B2-L

Dimensions

Download CAD data → www.festo.com

U-PK-3

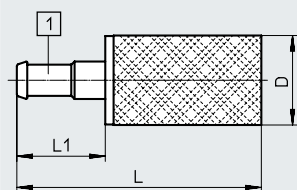

[1] Barbed connector for tubing I.D. 3

U-PK-4

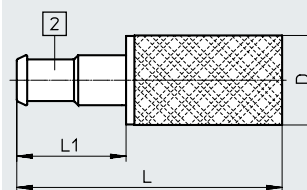

[2] Barbed connector for tubing I.D. 4

Ordering data	D ∅	L	L1	Part no.	Type	PJ ¹⁾
Pneumatic connection						
PK-3	8.6	23.5	8.5	4646	U-PK-3	10
PK-4	8.6	25.5	10.5	4932	U-PK-4	10

- 1) Packaging unit

Datasheet – Polymer design, male thread

Function

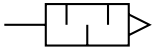

- To reduce noise at the exhaust ports of pneumatic components



General technical data							
Pneumatic connection		G1/8	G1/4	G3/8	G1/2	G3/4	G1
Mounting position		Any					
Noise level ¹⁾	[dB (A)]	< 74	< 76	< 82	< 82	< 85	< 90
Flow rate with respect to atmosphere ²⁾	[l/min]	2000	3300	6000	10300	17600	20800
Product weight	[g]	2.3	7.7	29.6	58.2	83	139.8

1) Measured at 0.6 MPa with respect to atmosphere at a distance of 1 m
 2) Measured at p1 = 0.6 MPa

Operating and environmental conditions		
Operating pressure	[MPa]	0 ... 1
	[bar]	0 ... 10
	[psi]	0 ... 145
Operating medium	Compressed air to ISO 8573-1:2010 [7:-:-]	
Note on the operating/pilot medium	Lubricated operation possible	
Ambient temperature	[°C]	-10 ... +70

Materials	
Housing	POM
Cushioning insert	PE
Note on materials	RoHS-compliant
LABS (PWIS) conformity	VDMA24364-B1/B2-L

Dimensions

Download CAD data → www.festo.com

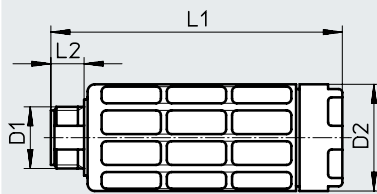

★ Core Range

Ordering data						
Pneumatic connection	D2	L1	L2	Part no.	Type	PU ¹⁾
D1	∅					
G1/8	15.2	35.9	5.5	★ 2307	U-1/8	1
				534222	U-1/8-50	50
G1/4	19	57	6.5	★ 2316	U-1/4	1
				534223	U-1/4-20	20
G3/8	33.5	78.8	7.5	★ 2309	U-3/8	1
				534224	U-3/8-20	20
G1/2	43	88.1	9	★ 2310	U-1/2	1
				534225	U-1/2-20	20
G3/4	45	120.7	10.5	★ 2311	U-3/4	1
G1	55	126.5	11.5	★ 2312	U-1	1

1) Packaging unit

Datasheet – Polymer design, female thread

Function

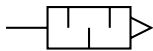

- To reduce noise at the exhaust ports of pneumatic components

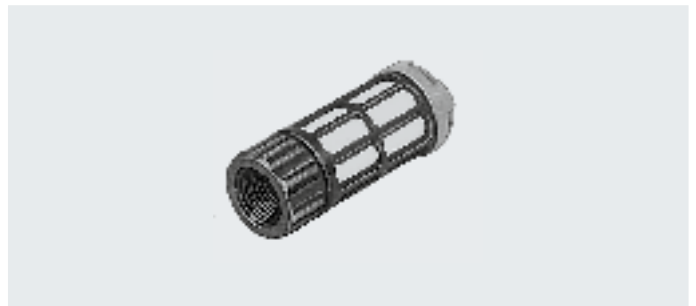

General technical data		
Pneumatic connection		G1/8
Mounting position		Any
Noise level ¹⁾	[dB (A)]	< 76.5
Flow rate with respect to atmosphere ²⁾	[l/min]	2050
Product weight	[g]	3.6

- 1) Measured at 0.6 MPa with respect to atmosphere at a distance of 1 m
 2) Measured at p₁ = 0.6 MPa

Operating and environmental conditions		
Operating pressure	[MPa]	0 ... 1
	[bar]	0 ... 10
Operating medium		Compressed air to ISO 8573-1:2010 [7:--]
Note on the operating/pilot medium		Lubricated operation possible
Ambient temperature	[°C]	-10 ... +70

Materials	
Housing	POM
Cushioning insert	PE
Note on materials	RoHS-compliant
LABS (PWIS) conformity	VDMA24364-B1/B2-L

Dimensions

Download CAD data → www.festo.com

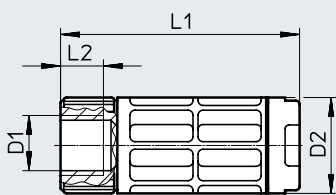

Ordering data					
Pneumatic connection	D2	L1	L2	Part no.	Type
D1	∅				
G1/8	15.2	38	6.5	3670	U-1/8-I

Datasheet – Die-cast design

Function

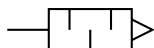

- To reduce noise at the exhaust ports of pneumatic components



General technical data		G1/8	G1/4	G3/8	G1/2	G3/4	G1
Pneumatic connection							
Mounting position		Any					
Noise level ¹⁾	[dB (A)]	< 74	< 80	< 80	< 81	< 83	< 85
Flow rate with respect to atmosphere ²⁾	[l/min]	1340	2440	5800	7500	10000	17500
Product weight	[g]	8	17	37	75	120	233

1) Measured at 0.6 MPa with respect to atmosphere at a distance of 1 m

2) Measured at p1 = 0.6 MPa

Operating and environmental conditions			
Operating pressure for full temperature range	[MPa]	0 ... 1	
	[bar]	0 ... 10	
	[psi]	0 ... 145	
Operating medium		Compressed air to ISO 8573-1:2010 [7:-:-]	
Note on the operating/pilot medium		Lubricated operation possible	
Ambient temperature	[°C]	-10 ... +70	
Corrosion resistance class CRC ¹⁾		1 - Low corrosion stress	

1) More information: www.festo.com/x/topic/crc

Materials		
Housing		Aluminium
Screwed plug		Aluminium
Cushioning insert		PE
Note on materials		RoHS-compliant
LABS (PWIS) conformity		VDMA24364-B1/B2-L

Dimensions

Download CAD data → www.festo.com

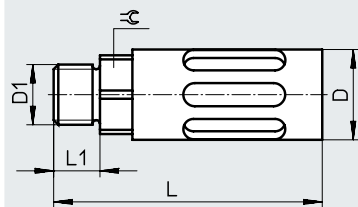

Ordering data		D	L	L1	±ε	Part no.	Type
Pneumatic connection	D1	∅					
G1/8		16	39.2	5.5	14	6841	U-1/8-B
G1/4		19.5	55.6	6.5	17	6842	U-1/4-B
G3/8		25	86.6	7.5	19	6843	U-3/8-B
G1/2		28	116.5	9	24	6844	U-1/2-B
G3/4		38	138	10.5	32	6845	U-3/4-B
G1		47.8	177	11.5	36	151990	U-1-B

Datasheet – Die-cast design

Function

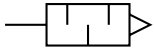

- To reduce noise at the exhaust ports of pneumatic components



General technical data

Pneumatic connection		3/4 NPT
Mounting position		Any
Noise level ¹⁾	[dB (A)]	< 81
Flow rate with respect to atmosphere ²⁾	[l/min]	11834
Product weight	[g]	128

- 1) Measured at 0.6 MPa with respect to atmosphere at a distance of 1 m
 2) Measured at p1 = 0.6 MPa

Operating and environmental conditions

Operating pressure for full temperature range	[MPa]	0 ... 1
	[bar]	0 ... 10
	[psi]	0 ... 145
Operating medium		Compressed air to ISO 8573-1:2010 [7:-:-]
Note on the operating/pilot medium		Lubricated operation possible
Ambient temperature	[°C]	-10 ... +70
Corrosion resistance class CRC ¹⁾		1 - Low corrosion stress

- 1) More information: www.festo.com/x/topic/crc

Materials

Housing	Aluminium
Screwed plug	Aluminium
Cushioning insert	PE
Note on materials	RoHS-compliant
LABS (PWIS) conformity	VDMA24364-B1/B2-L

Dimensions

Download CAD data → www.festo.com

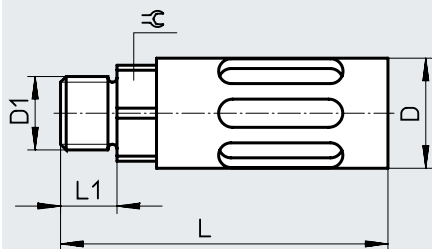

Ordering data

Pneumatic connection	D	L	L1	±ε	Part no.	Type
D1	∅					
3/4 NPT	38	151	18	30	566823	U-3/4-B-NPT

Datasheet – Design with push-in sleeve

Function

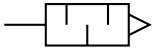

- To reduce noise at the exhaust ports of pneumatic components
- For QS push-in fittings 3 ... 10 mm



General technical data

Push-in sleeve ø	3	4	6	8	10
Mounting position	Any				
Noise level ¹⁾ [dB (A)]	< 60	< 60	< 60	< 60	< 68
Flow rate with respect to atmosphere ²⁾ [l/min]	170	350	800	1500	3100
Product weight [g]	0.4	0.5	1.1	2.3	5.5

1) Measured at 0.6 MPa with respect to atmosphere at a distance of 1 m

2) Measured at p₁ = 0.6 MPa

Operating and environmental conditions

Operating pressure	[MPa]	0 ... 1
	[bar]	0 ... 10
	[psi]	0 ... 145
Operating medium	Compressed air to ISO 8573-1:2010 [7:-:-]	
Note on the operating/pilot medium	Lubricated operation possible	
Ambient temperature [°C]	-10 ... +70	

Materials

Screwed plug	PE
Cushioning insert	PE
Note on materials	RoHS-compliant
LABS (PWIS) conformity	VDMA24364-B1/B2-L

Dimensions

Download CAD data → www.festo.com

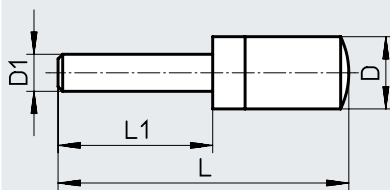

Ordering data

Push-in sleeve ø	D	L	L1	Part no.	Type
D1	ø				
3	7.8 +0.1/-0.3	29.1 ±0.6	14.4 ±0.2	165005	UC-QS-3H
4	7.8 +0.1/-0.3	31.0 ±0.6	16.3 ±0.2	165006	UC-QS-4H
6	9.8 -0.4	41.3 +1.4	17.2	165007	UC-QS-6H
8	13.8 +0.2/-0.3	54.4 +0.5/-1.0	23.4	175611	UC-QS-8H
10	17.8 -0.3	68.7 +0.2/-0.8	26.7	526475	UC-QS-10H

Datasheet – Design with threaded connection

Function

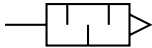

- To reduce noise at the exhaust ports of pneumatic components
- For solenoid valves CPE, Compact Performance



General technical data		M5	M7	G1/8	G1/4	G3/8
Pneumatic connection		M5	M7	G1/8	G1/4	G3/8
Mounting position		Any				
Noise level ¹⁾	[dB (A)]	< 60	< 58	< 59	< 60	< 60
Flow rate with respect to atmosphere ²⁾	[l/min]	350	800	1700	3200	5000
Product weight	[g]	0.4	1.2	2.6	5.2	10.5

- 1) Measured at 0.6 MPa with respect to atmosphere at a distance of 1 m
 2) Measured at p₁ = 0.6 MPa

Operating and environmental conditions		
Operating pressure	[MPa]	0 ... 1
	[bar]	0 ... 10
	[psi]	0 ... 145
Operating medium	Compressed air to ISO 8573-1:2010 [7:-:-]	
Note on the operating/pilot medium	Lubricated operation possible	
Ambient temperature	[°C]	-10 ... +70

Materials	
Screwed plug	PE
Cushioning insert	PE
Note on materials	RoHS-compliant
LABS (PWIS) conformity	VDMA24364-B1/B2-L

Dimensions

Download CAD data → www.festo.com

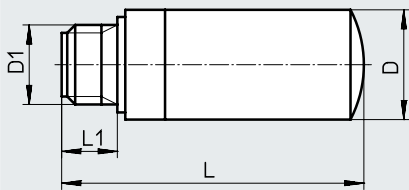

Ordering data		D	L	L1	Part no.	Type	PU ¹⁾
Pneumatic connection	D1	Ø					
M5		7.8 +0.1/-0.3	19.4 +0.6/-0.8	4.5 ±0.2	165003	UC-M5	1
					534217	UC-M5-50 ²⁾	50
M7		9.8 -0.4	30.7 +0.6/-0.8	5.5 -0.5	161418	UC-M7	1
					534218	UC-M7-50 ²⁾	50
G1/8		13.8 +0.2/-0.3	38.0 +0.8/-1.0	6.5 ±0.1	161419	UC-1/8	1
					534219	UC-1/8-50 ²⁾	50
G1/4		17.8 -0.3	50.8 +0.8/-1.0	8.5 ±0.15	165004	UC-1/4	1
					534220	UC-1/4-20 ²⁾	20
G3/8		22.1 -0.4	69.5 +0.6/-0.8	9.5 ±0.1	1707427	UC-3/8	1
					576759	UC-3/8-20 ²⁾	20

- 1) Packaging unit
 2) LABS (PWIS) conformity: VDMA24364-B2-L

Datasheet

Function

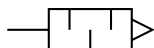

- For solenoid valves VUVB-ST12/ valve terminal VTUB-12
- Mounting via PIN (spring clip), included in the scope of delivery of the valve



General technical data

Pneumatic connection		Cartridge 10 mm
Mounting position		Any
Noise level ¹⁾	[dB (A)]	≤ 58
Flow rate with respect to atmosphere ²⁾	[l/min]	800
Product weight	[g]	2.0

1) Measured at 0.6 MPa with respect to atmosphere at a distance of 1 m

2) Measured at p1 = 0.6 MPa

Operating and environmental conditions

Operating pressure	[MPa]	0 ... 1
	[bar]	0 ... 10
	[psi]	0 ... 145
Operating medium		Compressed air to ISO 8573-1:2010 [7:-:-]
Note on the operating/ pilot medium		Lubricated operation possible
Ambient temperature	[°C]	-5 ... +60

Materials

Screwed plug	PE
Cushioning insert	PE
Note on materials	RoHS-compliant
LABS (PWIS) conformity	VDMA24364-B1/B2-L

Dimensions

Download CAD data → www.festo.com

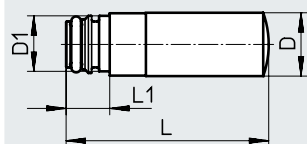

Ordering data

Pneumatic connection	D ∅	D1 ∅	L	L1	Part no.	Type	PU ¹⁾
Cartridge 10 mm	9.8	8.9	31.4	6.8	1224460	AMTC-P-PC10	1

1) Packaging unit

Datasheet – Short design

Function



- Suitable for reducing noise at the exhaust ports of pneumatic systems



General technical data		M5	G1/8	G1/4	G3/8	G1/2
Pneumatic connection						
Mounting position		Any				
Noise level ¹⁾	[dB (A)]	< 71	< 92	< 95	< 92	< 92
Flow rate with respect to atmosphere ²⁾	[l/min]	91	615	1000	1545	2745
Product weight	[g]	1.1	5	9.5	17	30

- 1) Measured at 0.6 MPa with respect to atmosphere at a distance of 1 m
 2) Measured at p1 = 0.6 MPa

Operating and environmental conditions		
Operating pressure	[MPa]	0 ... 1
	[bar]	0 ... 10
	[psi]	0 ... 145
Operating medium		Compressed air to ISO 8573-1:2010 [7:-;-]
Note on the operating/pilot medium		Lubricated operation possible
Ambient temperature	[°C]	-40 ... +80
Corrosion resistance class CRC ¹⁾		1 - Low corrosion stress

- 1) More information: www.festo.com/x/topic/crc

Materials	
Screwed plug	Brass
Cushioning insert	Bronze
Note on materials	RoHS-compliant
LABS (PWS) conformity	VDMA24364-B1/B2-L

Dimensions

Download CAD data → www.festo.com

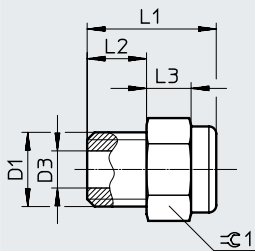

Ordering data		D3	L1	L2	L3	≅ 1	Part no.	Type	PU ¹⁾
Pneumatic connection	D1	∅	±0.5	±0.1		-0.2			
M5		2.5	8.7	4	3	6	1206621	AMTE-M-H-M5	20
G1/8		6.5	11.8	5.5	3.5	12	1206622	AMTE-M-H-G18	20
G1/4		9	13.8	6.5	4	15	1206623	AMTE-M-H-G14	20
G3/8		12	16.5	7.5	6	19	1206624	AMTE-M-H-G38	10
G1/2		15	19	10	6	24	1206625	AMTE-M-H-G12	10

- 1) Packaging unit

Datasheet – Long design

Function

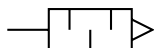

- Suitable for reducing noise at the exhaust ports of pneumatic systems



General technical data		M3	M5	G1/8	G1/4	G3/8	G1/2	G3/4	G1
Pneumatic connection									
Mounting position		Any							
Noise level ¹⁾	[dB (A)]	< 55	< 72	< 76	< 83	< 82	< 88	< 85	< 88
Flow rate with respect to atmosphere ²⁾	[l/min]	95	255	1735	3140	5430	10500	12400	17235
Product weight	[g]	0.4	1.5	7.5	13	26	43	80	115

1) Measured at 0.6 MPa with respect to atmosphere at a distance of 1 m

2) Measured at p1 = 0.6 MPa

Operating and environmental conditions		
Operating pressure	[MPa]	0 ... 1
	[bar]	0 ... 10
	[psi]	0 ... 145
Operating medium		Compressed air to ISO 8573-1:2010 [7:-:-]
Note on the operating/pilot medium		Lubricated operation possible
Ambient temperature	[°C]	-40 ... +80
Corrosion resistance class CRC ¹⁾		1 - Low corrosion stress

1) More information: www.festo.com/x/topic/crc

Materials	
Screwed plug	Brass
Cushioning insert	Bronze
Note on materials	RoHS-compliant
LABS (PWIS) conformity	VDMA24364-B1/B2-L

Datasheet – Long design

Dimensions

Download CAD data → www.festo.com

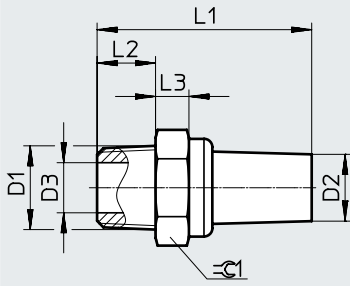

★ Core Range

Ordering data									
Pneumatic connection	D2	D3	L1	L2	L3	≡G1	Part no.	Type	PU ¹⁾
D1	∅	∅	±1	±0.1		-0.2			
M3	2	1.5	14	3	2	4	1231120	AMTE-M-LH-M3	20
M5	3	2.5	19.8	4	3	6	★ 1205858	AMTE-M-LH-M5	20
G1/8	8	6.5	23.7	5.5	3.5	12	★ 1205860	AMTE-M-LH-G18	20
G1/4	10	9	29	6.5	4	15	★ 1205861	AMTE-M-LH-G14	20
G3/8	12	12	41	7.5	6	19	★ 1205862	AMTE-M-LH-G38	10
G1/2	16	15	46.5	10	6	24	★ 1205863	AMTE-M-LH-G12	10
G3/4	20.5	20	50	10	6	30	1205864	AMTE-M-LH-G34	10
G1	20.5	26	59	10	6	36	1205865	AMTE-M-LH-G1	10

1) Packaging unit

Datasheet – Long design

Function

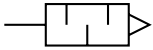

- Suitable for reducing noise at the exhaust ports of pneumatic systems



General technical data		10-32 UNF-2A	1/8 NPT	1/4 NPT	3/8 NPT	1/2 NPT
Pneumatic connection		10-32 UNF-2A	1/8 NPT	1/4 NPT	3/8 NPT	1/2 NPT
Mounting position		Any				
Noise level ¹⁾	[dB (A)]	< 71	< 77	< 82	< 83	< 85
Flow rate with respect to atmosphere ²⁾	[l/min]	260	1615	3080	5365	9240
Product weight	[g]	1.7	9	17	29	46

- 1) Measured at 0.6 MPa with respect to atmosphere at a distance of 1 m
 2) Measured at p1 = 0.6 MPa

Operating and environmental conditions		
Operating pressure	[MPa]	0 ... 1
	[bar]	0 ... 10
	[psi]	0 ... 145
Operating medium		Compressed air to ISO 8573-1:2010 [7:-:-]
Note on the operating/pilot medium		Lubricated operation possible
Ambient temperature	[°C]	-40 ... +80
Corrosion resistance class CRC ¹⁾		1 - Low corrosion stress

- 1) More information: www.festo.com/x/topic/crc

Materials	
Screwed plug	Brass
Cushioning insert	Bronze
Note on materials	RoHS-compliant
LABS (PWIS) conformity	VDMA24364-B2-L

Dimensions

Download CAD data → www.festo.com

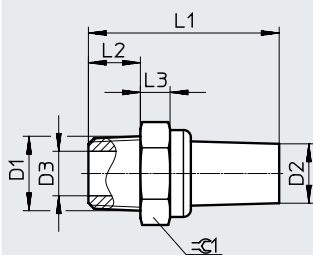

Ordering data		D2	D3	L1	L2	L3	±G1	Part no.	Type	PU ¹⁾
Pneumatic connection	D1	∅ ±0.5	∅	±1	±0.1		-0.2			
10-32 UNF-2A		3	2.5	20.3	4	3.5	6	1206994	AMTE-M-LH-U10	20
1/8 NPT		8	6	25.7	7	4	12	1206989	AMTE-M-LH-N18	20
1/4 NPT		10	9	34.5	11	5	15	1206990	AMTE-M-LH-N14	20
3/8 NPT		12	11.5	43.2	11	5.5	19	1206991	AMTE-M-LH-N38	10
1/2 NPT		16	15	49	13	5.5	24	1206992	AMTE-M-LH-N12	10

- 1) Packaging unit

Datasheet

Function

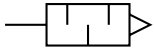

- Use only for vacuum generators VN-T2/T3
- Special minimal resistance silencer
- Facilitates trouble-free operation of the vacuum generator



General technical data					
Pneumatic connection		M5	M7	G1/8	G1/4
Mounting position		Any			
Design		Open silencer			
Product weight	[g]	0.5	2.5	5	8

Operating and environmental conditions		
Operating pressure	[MPa]	0 ... 0.8
	[bar]	0 ... 8
	[psi]	0 ... 116
Operating medium		Compressed air to ISO 8573-1:2010 [7:4:4]
Ambient temperature	[°C]	-10 ... +60

Materials	
Screwed plug	PE
Cushioning insert	PE
Note on materials	RoHS-compliant
LABS (PWIS) conformity	VDMA24364-B1/B2-L

Dimensions

Download CAD data → www.festo.com

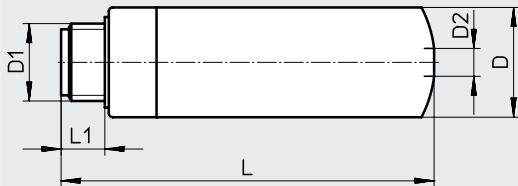

Ordering data						
Pneumatic connection	D	D2	L	L1	Part no.	Type
D1	∅	∅				
M5	7.8	2.1	19.3	4.5	8141085	UO-M5
M7	9.8	3	36.7	5.5	197582	UO-M7
G1/8	13.8	3.5	48	6.5	197583	UO-1/8
G1/4	17.8	5.3	62.3	8.5	197584	UO-1/4

Datasheet

Function

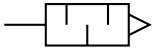

- Use only for vacuum generators VN-T4/T6
- Special minimal resistance silencer
- Facilitates trouble-free operation of the vacuum generator
- Silencer extension for extending the silencer for further noise reduction



General technical data		UOM-1/4	UOM-3/8	UOMS-1/4	UOMS-3/8
Pneumatic connection		G1/4	G3/8	–	
Design		Open silencer			
Type of mounting		Screw-in		Snap-in	
Mounting position		Any			
Type of seal on the screwed plug		No seal			
Product weight	[g]	11.1	22.7	8.6	17.5

Operating and environmental conditions		
Operating pressure of vacuum generator	[MPa]	0 ... 0.8
	[bar]	0 ... 8
	[psi]	0 ... 116
Ambient temperature	[°C]	0 ... +60
Corrosion resistance class	CRC ¹⁾	2 - Moderate corrosion stress

1) More information: www.festo.com/x/topic/crc

Materials	
Housing	POM
Inner pipe	Wrought aluminium alloy
Screwed plug	POM
Cushioning insert	Polyurethane foam
LABS (PWIS) conformity	VDMA24364-B2-L

Dimensions

UOM

Download CAD data → www.festo.com

UOMS

Ordering data							
Pneumatic connection	D	D2	L	L1	L2	Part no.	Type
D1	∅	∅					
Silencers							
G1/4	17.8	–	73	8	10	538432	UOM-1/4
G3/8	23.8	–	74	8.6	10.5	538433	UOM-3/8
Silencer extension							
For UOM-1/4	17.8	16	64.5	–	10	538436	UOMS-1/4
For UOM-3/8	23.8	22	65.2	–	10.5	538437	UOMS-3/8