

## Lubricators MS-LOE, MS series

**FESTO**



## Key features

### Service unit components of the MS series

#### Solutions for every application

With its large product range, highly effective components and a wide choice of functions, the MS series from Festo offers a complete concept for compressed air preparation. It is suitable for simple standard applications as well as application-specific solutions with very high quality requirements. Available as individual components, pre-assembled combinations ex-stock,

application-specific combinations or complete turnkey solutions. The five sizes in the MS series achieve maximum flow rates with minimum space requirements.

#### Freely combinable function modules

Pressure regulators, on/off and soft-start valves with safety function, filters, pressure and flow sensors, dryers, sensors and lubricators can be assembled into a suitable solution for every task. With the modular structure the components can be combined as required. The simple connection system saves time because the entire combination doesn't need to be disassembled

when replacing individual modules.

Many of the components are also UL and ATEX certified.

#### CAD models and configurator

Convenient tools for planning and selecting application-specific individual devices and combinations. The product configurator lets you configure customised solutions quickly and transfer the order data without any hassle.

#### Engineering tools

Selection tool for choosing the right service unit combination without oversizing, and with the right air purity class:

→ [www.festo.com/engineering/service-unit](http://www.festo.com/engineering/service-unit)



### Integrated sensors

Pressure and flow sensors



- Maximum machine availability thanks to controlled processes
- Reliable air preparation and supply for systems
- Integrated or stand-alone
- Easy to connect with M8/M12 plug

### Safety functions

Soft-start/quick exhaust valves

MS6-SV/MS9-SV



- Fast and reliable exhausting of systems up to Performance Level e, certified to EN ISO 13849-1
- Integrated soft-start function

### Saving energy

Service unit combinations MSE6



- Fully automatic monitoring and regulation of compressed air supply
- Automatic shut-off of the compressed air in stand-by mode
- Detection and notification of leaks
- Condition monitoring of relevant process data

Intelligent mix of sizes



- Optimum flow rate with a size that is up to 18% smaller
- Excellent energy efficiency
- Cost-optimised combinations – save up to 30%!

### Size differences

Size	MS2	MS4	MS6	MS9	MS12
Grid dimension [mm]	25	40	62	90	124
Connection sizes	M5, QS-6	G1/8, G1/4, G3/8	G1/4, G3/8, G1/2, G3/4	G1/2, G3/4, G1, G1 1/4, G1 1/2	G1, G1 1/4, G1 1/2, G2
Standard nominal flow rate qn <sup>1)</sup> [l/min]	350	1800	6500	20000	22000

1) Using pressure regulator MS-LR as an example

## Key features

### Note

#### Information

The next few pages provide a brief overview of the product range for the MS series service unit components.

You can find detailed information and all the technical data in the documentation for the relevant service unit component.





Accessories such as connecting plates or mounting brackets can be ordered either via the configurator or separately.

#### Design of a service unit combination







The order of the individual service unit components within a combination is relevant for safety and functionality. The service unit components cannot be combined in any order in the flow direction. They are subject to restrictions and rules.

The configurator for the service unit MSB is a reliable and convenient way of arranging individual service unit components and ensures compliance with the applicable rules. As a result, you get a completely assembled combination with UL or ATEX certification, if necessary. When combining a unit from individually configured and ordered service unit components, the following points must be adhered to under all circumstances.





- Regulators MS-LFR/LR/LRP/LRE are only permissible in the flow direction with the same or decreasing pressure regulation range
- Filters MS-LFR/LF/LFM/LFX are only permissible in the flow direction with an increasing grade of filtration
- Lubricators MS-LOE are not permitted in the flow direction upstream of a filter MS-LFR/LFM/LF/LFX, water separator MS-LWS or membrane air dryer MS-LDM1
- A micro filter MS-LFM must be installed in the flow direction upstream of an activated carbon filter MS-LFX or membrane air dryer MS-LDM1
- A flow sensor SFAM cannot be installed directly downstream of a regulator MS-LFR/LR; a branching module MS-FRM must be positioned between them
- A soft-start/quick exhaust valve MS-SV must be the last service unit component in the flow direction

Product range for MS series service unit components								
Type	Description	Size	Pneumatic connection					
			Push-in connector	Female thread			Connecting plate with thread	
				M	G	NPT	G	NPT
<b>Combinations</b>								
<b>Service unit combinations MSB-FRC</b>								Datasheets → Internet: msb
	Combinations of filter regulator and lubricator	4	–	–	1/8, 1/4	–	–	–
		6	–	–	1/4, 3/8, 1/2	–	–	–
<b>Service unit combinations MSB</b>								
<b>Service unit combinations MSB</b>								Datasheets → Internet: msb
	Certain predefined combinations	4	–	–	1/4	–	–	–
		6	–	–	1/2	–	–	–
	Freely configurable combinations	4	–	–	1/8, 1/4	–	1/8, 1/4, 3/8	1/8, 1/4, 3/8
		6	–	–	1/4, 3/8, 1/2	–	1/4, 3/8, 1/2, 3/4	1/4, 3/8, 1/2, 3/4
		9	–	–	3/4, 1	3/4, 1	1/2, 3/4, 1, 1 1/4, 1 1/2	1/2, 3/4, 1, 1 1/4, 1 1/2
<b>Service unit combinations MSE6</b>								
<b>Service unit combinations MSE6</b>								Datasheets → Internet: mse6
	Combinations with fieldbus connection for measuring pressure, flow rate and consumption	6	–	–	–	–	1/2	–

## Key features

Product range for MS series service unit components								
Type	Description	Size	Pneumatic connection				Connecting plate with thread	
			Push-in connector	Female thread				
			M	G	NPT	G	NPT	
<b>Individual devices</b>								
<b>Filter regulators MS-LFR</b>			Datasheets → Internet: ms2-lfr; ms4-lfr; ms6-lfr; ms9-lfr; ms12-lfr					
	Filter and pressure regulator in a single device, grade of filtration 5 or 40 µm	2	QS-6	M5	–	–	–	–
		4	–	–	1/8, 1/4	–	1/8, 1/4, 3/8	1/8, 1/4, 3/8
		6	–	–	1/4, 3/8, 1/2	–	1/4, 3/8, 1/2, 3/4	1/4, 3/8, 1/2, 3/4
		9	–	–	3/4, 1	3/4, 1	1/2, 3/4, 1, 1 1/4, 1 1/2	1/2, 3/4, 1, 1 1/4, 1 1/2
		12	–	–	–	–	1, 1 1/4, 1 1/2, 2	–
<b>Filter regulators MS-LFR-B</b>			Datasheets → Internet: ms4-lfr-b; ms6-lfr-b					
	Filter and pressure regulator in a single device in polymer housing, grade of filtration 5 or 40 µm	4	–	–	1/4	–	–	–
		6	–	–	1/2	–	–	–
<b>Filters MS-LF</b>			Datasheets → Internet: ms4-lf; ms6-lf; ms9-lf; ms12-lf					
	Grade of filtration 5 or 40 µm	4	–	–	1/8, 1/4	–	1/8, 1/4, 3/8	1/8, 1/4, 3/8
		6	–	–	1/4, 3/8, 1/2	–	1/4, 3/8, 1/2, 3/4	1/4, 3/8, 1/2, 3/4
		9	–	–	3/4, 1	3/4, 1	1/2, 3/4, 1, 1 1/4, 1 1/2	1/2, 3/4, 1, 1 1/4, 1 1/2
		12	–	–	–	–	1, 1 1/4, 1 1/2, 2	–
<b>Fine and micro filters MS-LFM</b>			Datasheets → Internet: ms4-lfm; ms6-lfm; ms9-lfm; ms12-lfm					
	Grade of filtration 0.01 or 1 µm	4	–	–	1/8, 1/4	–	1/8, 1/4, 3/8	1/8, 1/4, 3/8
		6	–	–	1/4, 3/8, 1/2	–	1/4, 3/8, 1/2, 3/4	1/4, 3/8, 1/2, 3/4
		9	–	–	3/4, 1	3/4, 1	1/2, 3/4, 1, 1 1/4, 1 1/2	1/2, 3/4, 1, 1 1/4, 1 1/2
		12	–	–	–	–	1, 1 1/4, 1 1/2, 2	–
<b>Activated carbon filters MS-LFX</b>			Datasheets → Internet: ms4-lfx; ms6-lfx; ms9-lfx; ms12-lfx					
	For removing liquid and gaseous oil particles	4	–	–	1/8, 1/4	–	1/8, 1/4, 3/8	1/8, 1/4, 3/8
		6	–	–	1/4, 3/8, 1/2	–	1/4, 3/8, 1/2, 3/4	1/4, 3/8, 1/2, 3/4
		9	–	–	3/4, 1	3/4, 1	1/2, 3/4, 1, 1 1/4, 1 1/2	1/2, 3/4, 1, 1 1/4, 1 1/2
		12	–	–	–	–	1, 1 1/4, 1 1/2, 2	–
<b>Water separators MS-LWS</b>			Datasheets → Internet: ms6-lws; ms9-lws; ms12-lws					
	Remove condensate from compressed air, maintenance-free	6	–	–	1/4, 3/8, 1/2	–	1/4, 3/8, 1/2, 3/4	1/4, 3/8, 1/2, 3/4
		9	–	–	3/4, 1	3/4, 1	1/2, 3/4, 1, 1 1/4, 1 1/2	1/2, 3/4, 1, 1 1/4, 1 1/2
		12	–	–	–	–	1, 1 1/4, 1 1/2, 2	–





## Key features

Product range for MS series service unit components								
Type	Description	Size	Pneumatic connection					
			Push-in connector	Female thread			Connecting plate with thread	
				M	G	NPT	G	NPT
<b>Individual devices</b>								
<b>Pressure regulators MS-LR</b> <span style="float: right;">Datasheets → Internet: ms2-lr; ms4-lr; ms6-lr; ms9-lr; ms12-lr</span>								
	For setting the required operating pressure, 4 pressure regulation ranges	2	QS-6	M5	–	–	–	–
		4	–	–	1/8, 1/4	–	1/8, 1/4, 3/8	1/8, 1/4, 3/8
		6	–	–	1/4, 3/8, 1/2	–	1/4, 3/8, 1/2, 3/4	1/4, 3/8, 1/2, 3/4
		9	–	–	3/4, 1	3/4, 1	1/2, 3/4, 1, 1 1/4, 1 1/2	1/2, 3/4, 1, 1 1/4, 1 1/2
		12	–	–	–	–	1, 1 1/4, 1 1/2, 2	–
<b>Pressure regulators MS-LR-B</b> <span style="float: right;">Datasheets → Internet: ms4-lr-b; ms6-lr-b</span>								
	For setting the required operating pressure, in polymer housing	4	–	–	1/4	–	–	–
		6	–	–	1/2	–	–	–
<b>Pressure regulators MS-LRB</b> <span style="float: right;">Datasheets → Internet: ms4-lrb; ms6-lrb</span>								
	For configuring a regulator manifold with independent pressure regulation ranges. Pressure output is to the front or rear.	4	–	–	1/4	–	1/8, 1/4, 3/8	–
		6	–	–	1/2	–	1/4, 3/8, 1/2, 3/4	–
<b>Precision pressure regulators MS-LRP</b> <span style="float: right;">Datasheets → Internet: ms6-lrp</span>								
	For precisely setting the required operating pressure, 4 pressure regulation ranges, pressure hysteresis 0.02 bar	6	–	–	1/4, 3/8, 1/2	–	1/4, 3/8, 1/2, 3/4	1/4, 3/8, 1/2, 3/4
<b>Precision pressure regulators MS-LRPB</b> <span style="float: right;">Datasheets → Internet: ms6-lrpb</span>								
	For configuring a regulator manifold with independent pressure regulation ranges. Pressure output is to the front or rear.	6	–	–	1/2	–	1/4, 3/8, 1/2, 3/4	–
<b>Lubricators MS-LOE</b> <span style="float: right;">Datasheets → Internet: ms4-loe; ms6-loe; ms9-loe; ms12-loe</span>								
	Add a precisely adjustable amount of oil to the compressed air. The amount of oil mist is proportional to the compressed air flow rate.	4	–	–	1/8, 1/4	–	1/8, 1/4, 3/8	1/8, 1/4, 3/8
		6	–	–	1/4, 3/8, 1/2	–	1/4, 3/8, 1/2, 3/4	1/4, 3/8, 1/2, 3/4
		9	–	–	3/4, 1	3/4, 1	1/2, 3/4, 1, 1 1/4, 1 1/2	1/2, 3/4, 1, 1 1/4, 1 1/2
		12	–	–	–	–	1, 1 1/4, 1 1/2, 2	–

## Key features

Product range for MS series service unit components								
Type	Description	Size	Pneumatic connection					
			Push-in connector	Female thread			Connecting plate with thread	
				M	G	NPT	G	NPT
<b>Individual devices</b>								
<b>On/off valves MS-EM</b> <span style="float: right;">Datasheets → Internet: ms4-em; ms6-em; ms9-em; ms12-em</span>								
	Manually actuated on/off valve for pressurising and exhausting pneumatic systems.	4	–	–	1/8, 1/4	–	1/8, 1/4, 3/8	1/8, 1/4, 3/8
		6	–	–	1/4, 3/8, 1/2	–	1/4, 3/8, 1/2, 3/4	1/4, 3/8, 1/2, 3/4
		9	–	–	3/4, 1	3/4, 1	1/2, 3/4, 1, 1 1/4, 1 1/2	1/2, 3/4, 1, 1 1/4, 1 1/2
		12	–	–	–	–	1, 1 1/4, 1 1/2, 2	–
<b>On/off valves MS-EE</b> <span style="float: right;">Datasheets → Internet: ms4-ee; ms6-ee; ms9-ee; ms12-ee</span>								
	Electrically actuated on/off valve for pressurising and exhausting pneumatic systems.	4	–	–	1/8, 1/4	–	1/8, 1/4, 3/8	1/8, 1/4, 3/8
		6	–	–	1/4, 3/8, 1/2	–	1/4, 3/8, 1/2, 3/4	1/4, 3/8, 1/2, 3/4
		9	–	–	3/4, 1	3/4, 1	1/2, 3/4, 1, 1 1/4, 1 1/2	1/2, 3/4, 1, 1 1/4, 1 1/2
		12	–	–	–	–	1, 1 1/4, 1 1/2, 2	–
<b>On/off valves MS-EE-B</b> <span style="float: right;">Datasheets → Internet: ms4-ee-b; ms6-ee-b</span>								
	Electrically actuated on/off valve in polymer housing for pressurising and exhausting pneumatic systems.	4	–	–	1/4	–	–	–
		6	–	–	1/2	–	–	–
<b>Soft-start valves MS-DL</b> <span style="float: right;">Datasheets → Internet: ms4-dl; ms6-dl; ms12-dl</span>								
	Pneumatically actuated soft-start valve for slowly pressurising and exhausting pneumatic systems.	4	–	–	1/8, 1/4	–	1/8, 1/4, 3/8	1/8, 1/4, 3/8
		6	–	–	1/4, 3/8, 1/2	–	1/4, 3/8, 1/2, 3/4	1/4, 3/8, 1/2, 3/4
		12	–	–	–	–	1, 1 1/4, 1 1/2, 2	–
<b>Soft-start valves MS-DE</b> <span style="float: right;">Datasheets → Internet: ms4-de; ms6-de; ms12-de</span>								
	Electrically actuated soft-start valve for slowly pressurising and exhausting pneumatic systems.	4	–	–	1/8, 1/4	–	1/8, 1/4, 3/8	1/8, 1/4, 3/8
		6	–	–	1/4, 3/8, 1/2	–	1/4, 3/8, 1/2, 3/4	1/4, 3/8, 1/2, 3/4
		12	–	–	–	–	1, 1 1/4, 1 1/2, 2	–
<b>On/off valves MS-EDE-B</b> <span style="float: right;">Datasheets → Internet: ms4-edeb; ms6-edeb</span>								
	Electrically actuated soft-start valve in polymer housing for slowly pressurising and exhausting pneumatic systems.	4	–	–	1/4	–	–	–
		6	–	–	1/2	–	–	–
<b>Soft-start/quick exhaust valves MS-SV</b> <span style="float: right;">Datasheets → Internet: ms6-sv; ms9-sv</span>								
	For gradually increasing pressurisation and quick, safe pressure reduction in pneumatic piping systems. Up to category 1, PL c.	6	–	–	1/2	–	1/4, 3/8, 1/2, 3/4	1/4, 3/8, 1/2, 3/4
		9	–	–	3/4, 1	3/4, 1	1/2, 3/4, 1, 1 1/4, 1 1/2	1/2, 3/4, 1, 1 1/4, 1 1/2
	Up to category 3, PL d. Up to category 4, PL e in the case of optional extension.	6	–	–	1/2	–	1/4, 3/8, 1/2, 3/4	1/4, 3/8, 1/2, 3/4
	Up to category 4, PL e.	6	–	–	1/2	–	1/4, 3/8, 1/2, 3/4	–

## Key features

Product range for MS series service unit components								
Type	Description	Size	Pneumatic connection					
			Push-in connector	Female thread			Connecting plate with thread	
				M	G	NPT	G	NPT
<b>Individual devices</b>								
<b>Membrane air dryers MS-LDM1</b> <span style="float: right;">Datasheets → Internet: ms4-ldm; ms6-ldm</span>								
	Wear-free membrane dryer with internal air consumption	4	–	–	1/8, 1/4	–	1/8, 1/4, 3/8	1/8, 1/4, 3/8
		6	–	–	1/4, 3/8, 1/2	–	1/4, 3/8, 1/2, 3/4	1/4, 3/8, 1/2, 3/4
<b>Branching modules MS-FRM</b> <span style="float: right;">Datasheets → Internet: ms4-frm; ms6-frm; ms9-frm; ms12-frm</span>								
	Compressed air distributors with 4 connections	4	–	–	1/8, 1/4	–	1/8, 1/4, 3/8	–
		6	–	–	1/4, 3/8, 1/2	–	1/4, 3/8, 1/2, 3/4	–
		9	–	–	3/4, 1	3/4, 1	1/2, 3/4, 1, 1 1/4, 1 1/2	1/2, 3/4, 1, 1 1/4, 1 1/2
		12	–	–	–	–	1, 1 1/4, 1 1/2, 2	–
<b>Distributor blocks MS-FRM-FRZ</b> <span style="float: right;">Datasheets → Internet: ms4-frm-frz; ms6-frm-frz</span>								
	Compressed air distributors with 4 connections and half the grid width	4	–	–	–	–	–	–
		6	–	–	–	–	–	–
<b>Flow sensors SFAM</b> <span style="float: right;">Datasheets → Internet: sfam</span>								
	For absolute flow rate information and cumulative air consumption measurement	6	–	–	–	–	1/2	1/2
		9	–	–	–	–	1, 1 1/2	1, 1 1/2

Peripherals overview

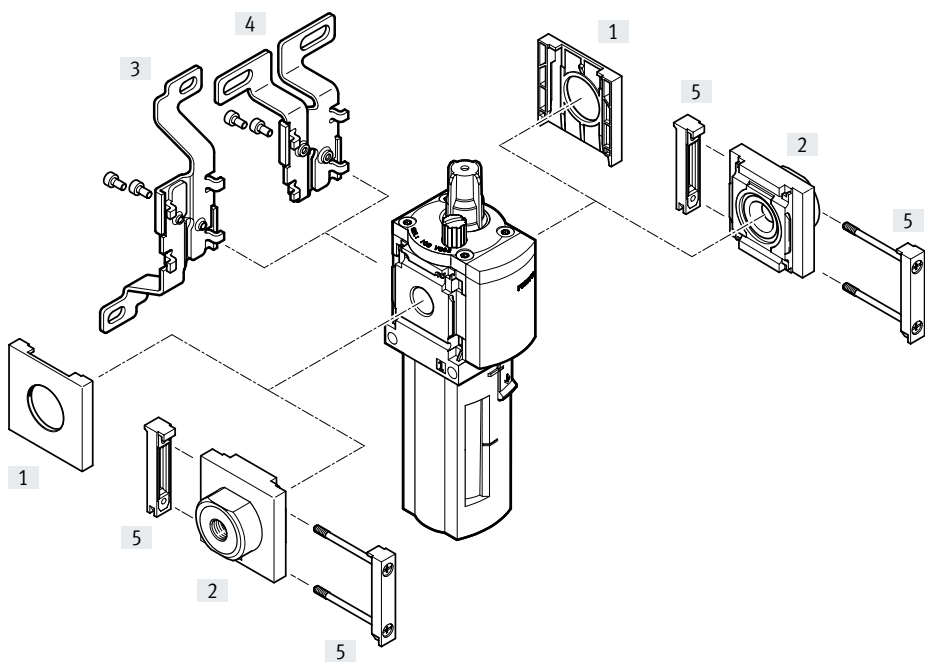

**Note**

Additional accessories:

- Module connector for combination with size MS4/MS6 or size MS9  
→ Internet: amv, rmv, armv
- Adapter for mounting on profiles  
→ Internet: ipm-80, ipm-40-80, ipm-80-80

Mounting attachments and accessories

		Individual device		Combination		→ Page/Internet
		Without connecting plate	With connecting plate	Without connecting plate	With connecting plate	
[1]	Cover cap MS4/6-END	■	-	■	-	ms4-end, ms6-end
[2]	Connecting plate SET MS4/6-AG...	-	■	-	■	ms4-ag, ms6-ag
	Connecting plate SET MS4/6-AQ...	-	■	-	■	ms4-aq, ms6-aq
[3]	Mounting bracket MS4/6-WB	■	■	-	-	ms4-wb, ms6-wb
[4]	Mounting bracket MS4-WBM	■	■	-	-	ms4-wbm
[5]	Module connector MS4/6-MV	-	■	■	■	ms4-mv, ms6-mv
-	Mounting bracket MS4/6-WP/WPB/WPE/WPM	-	■	■	■	ms4-wp, ms6-wp



## Type codes

## MS4-LOE

001	Series
<b>MS</b>	MS series
002	Size
<b>4</b>	Grid dimension 40 mm
003	Function
<b>LOE</b>	Compressed air lubricator
004	Pneumatic connection
<b>1/8</b>	Female thread G1/8
<b>1/4</b>	Female thread G1/4
<b>AGA</b>	Sub-base G1/8
<b>AGB</b>	Sub-base G1/4
<b>AGC</b>	Sub-base G3/8
<b>AQK</b>	Sub-base 1/8 NPT
<b>AQN</b>	Sub-base 1/4 NPT
<b>AQP</b>	Sub-base 3/8 NPT
005	Bowl type
<b>R</b>	Plastic tray with plastic basket
<b>U</b>	Metal bowl

006	Type of mounting
	Without mounting bracket
<b>WP</b>	Mounting bracket basic design
<b>WPM</b>	Mounting bracket for hooking in service unit components
<b>WB</b>	Mounting centrally at rear (wall mounting top and bottom), connecting plates not required
<b>WBM</b>	Mounting centrally at rear (wall mounting top), connecting plates not required

007	EU certification
	None
<b>EX4</b>	II 2GD

008	UL certification
	None
<b>UL1</b>	cULus ordinary location for Canada and USA

009	Flow direction
	Flow direction from left to right
<b>Z</b>	Flow direction from right to left

## MS6-LOE

001	Series
<b>MS</b>	MS series
002	Size
<b>6</b>	Grid dimension 62 mm
003	Function
<b>LOE</b>	Compressed air lubricator
004	Pneumatic connection
<b>1/4</b>	Female thread G1/4
<b>3/8</b>	Female thread G3/8
<b>1/2</b>	Female thread G1/2
<b>AGB</b>	Sub-base G1/4
<b>AGC</b>	Sub-base G3/8
<b>AGD</b>	Sub-base G1/2
<b>AGE</b>	Sub-base G3/4
<b>AQN</b>	Sub-base 1/4 NPT
<b>AQP</b>	Sub-base 3/8 NPT
<b>AQR</b>	Sub-base 1/2 NPT
<b>AQS</b>	Sub-base 3/4 NPT

005	Bowl type
<b>R</b>	Plastic tray with plastic basket
<b>U</b>	Metal bowl

006	Type of mounting
	Without mounting bracket
<b>WP</b>	Mounting bracket basic design
<b>WPM</b>	Mounting bracket for hooking in service unit components
<b>WB</b>	Mounting centrally at rear (wall mounting top and bottom), connecting plates not required

007	EU certification
	None
<b>EX4</b>	II 2GD





008	UL certification
	None
<b>UL1</b>	cULus ordinary location for Canada and USA

009	Flow direction
	Flow direction from left to right
<b>Z</b>	Flow direction from right to left

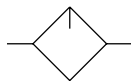
## Datasheet

### Function



-  - Flow rate  
1100 ... 7200 l/min
-  - Temperature range  
-10 ... +60°C
-  - Operating pressure  
1 ... 16 bar
-  - Spare parts management



The proportional lubricator adds a precisely adjustable amount of oil to the compressed air.

The pressure drop that occurs when air flows through a Venturi nozzle is used to feed oil from the reservoir to the drip cap.

From here, the oil drips into the air duct directly behind the proportional valve, where it is atomised. The amount of oil mist is proportional to the compressed air flow rate.

- Proportional lubricator with precision oil metering
- Reduces wear on drive units subject to high loads
- High flow rate
- Quick and easy oil top-up even during operation (under pressure)
- Optional device variant EX4 for use in potentially explosive areas in zones 1, 2, 21 and 22

The following oils are recommended for Festo components:  
Viscosity range to ISO 3448, ISO class VG 32

- 32 mm<sup>2</sup>/s (= cSt) at 40 °C
- Festo special oil OFSW-32 → 29
- Castrol HySpin ZZ 32
- BP Energol HLP 32
- Mobil Nuto H 32
- Mobil DTE 24
- Shell Tellus S2 MA 32

### General technical data

Size	MS4	MS6
Pneumatic connection 1, 2		
Female thread	G1/8 or G1/4	G1/4, G3/8 or G1/2
Connecting plate [AG...]	G1/8, G1/4 or G3/8	G1/4, G3/8, G1/2 or G3/4
[AQ...]	1/8 NPT, 1/4 NPT or 3/8 NPT	1/4 NPT, 3/8 NPT, 1/2 NPT or 3/4 NPT
Design	Proportional standard mist lubricator	
Type of mounting	Via accessories In-line installation	
Mounting position	Vertical ±5°	
Bowl guard	Plastic bowl guard Integrated as metal bowl	
Minimum flow rate for lubricator function [l/min]	40	50
Max. oil capacity [cm <sup>3</sup> ]	30 (with plastic bowl guard) 36 (with metal bowl)	75 (with plastic bowl guard) 80 (with metal bowl)

† Note: This product conforms to ISO 1179-1 and ISO 228-1.

### Standard nominal flow rate q<sub>nN</sub> [l/min]

Size	MS4		MS6		
Pneumatic connection 1, 2	G1/8	G1/4	G1/4	G3/8	G1/2
In main flow direction 1 > 2	1100	2200	2500	5300	7200

## Datasheet

Operating and environmental conditions		
Size	MS4	MS6
Operating pressure [bar]	1 ... 12 (1 ... 10) <sup>1)</sup>	1 ... 16 (1 ... 10) <sup>1)</sup>
Operating medium	Compressed air to ISO 8573-1:2010 [7:4:4] Inert gases	
Note on the operating/pilot medium	Operation with lubricated medium possible	
Ambient temperature [°C]	-10 ... +60	
Temperature of medium [°C]	-10 ... +60	
Storage temperature [°C]	-10 ... +60	
Corrosion resistance class CRC <sup>2)</sup>	2	
Food-safe <sup>3)</sup>	See supplementary material information	
UL certification <sup>3)</sup>	c UL us - Recognized (OL)	

1) Value in brackets applies to MS4/MS6-LOE with UL certification.

2) More information [www.festo.com/x/topic/crc](http://www.festo.com/x/topic/crc)

3) More information: [www.festo.com/catalogue/ms-loe](http://www.festo.com/catalogue/ms-loe) → Support/Downloads.

ATEX	
EU certification	EX4
ATEX category for gas	II 2G
Type of (ignition) protection for gas	Ex h IIC T6 Gb X
ATEX category for dust	II 2D
Type of (ignition) protection for dust	Ex h IIIC T60°C Db X
Explosion ambient temperature	-10°C ≤ Ta ≤ +60°C
Explosion protection certification outside the EU	EPL Db (GB) EPL Gb (GB)
CE marking (see declaration of conformity) <sup>1)</sup>	To EU Explosion Protection Directive (ATEX)
UKCA marking (see declaration of conformity) <sup>1)</sup>	To UK regulations for explosions

1) More information: [www.festo.com/catalogue/ms-loe](http://www.festo.com/catalogue/ms-loe) → Support/Downloads.

Weight [g]		
Size	MS4	MS6
Lubricator with plastic bowl guard	194	600
Lubricator with metal bowl	354	810

### Materials

#### Sectional view

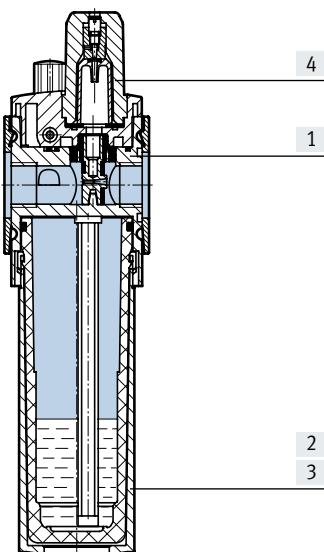

Lubricators		
[1]	Housing	Die-cast aluminium
[2]	Plastic bowl guard	PC
[3]	Metal bowl Inspection window	Wrought aluminium alloy PA
[4]	Lubricator dome	PC
-	Seals	NBR
Note on materials		RoHS-compliant
LABS (PWIS) conformity		VDMA24364-B1/B2-L

Datasheet

Standard flow rate  $q_n$  as a function of differential pressure  $p_{1,2}$

MS4-LOE-1/8

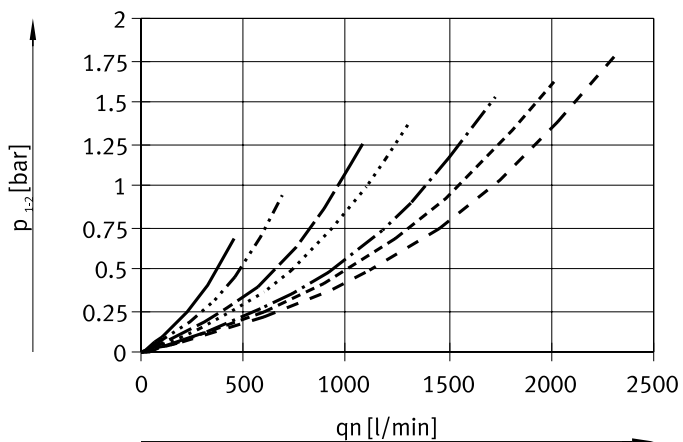

MS4-LOE-1/4

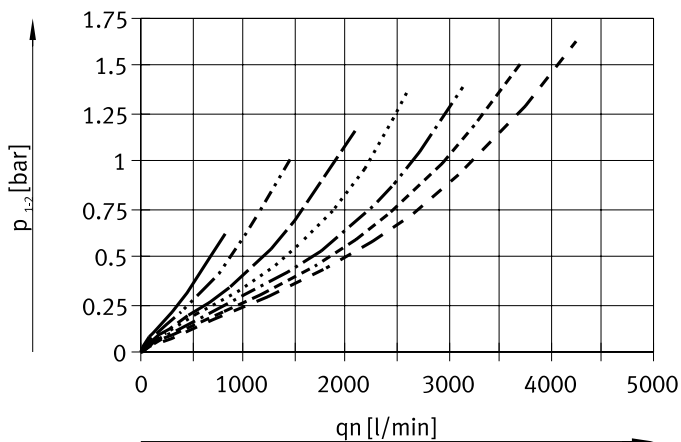

MS6-LOE-1/4

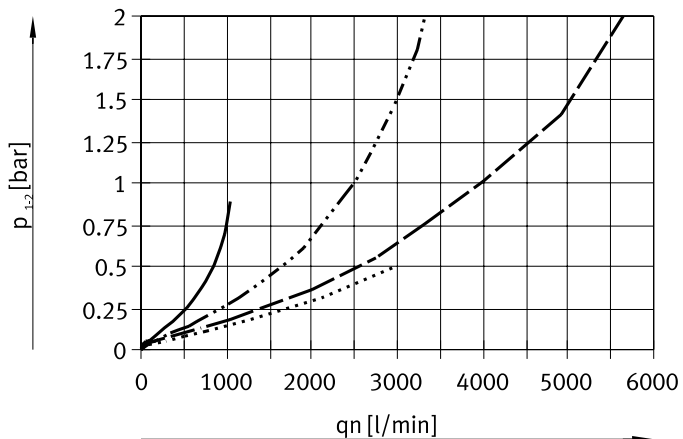

MS6-LOE-3/8

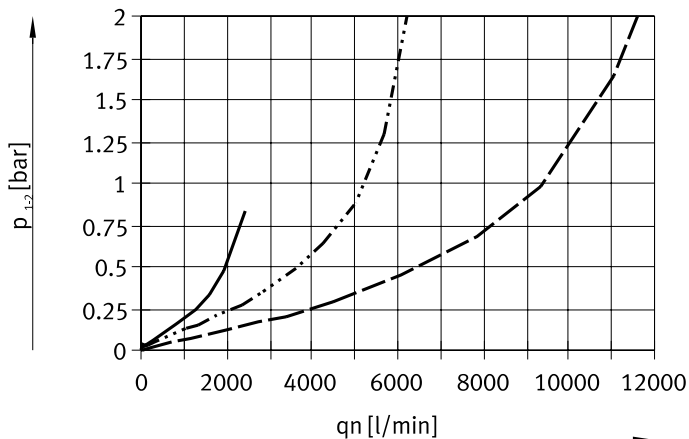

MS6-LOE-1/2

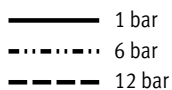
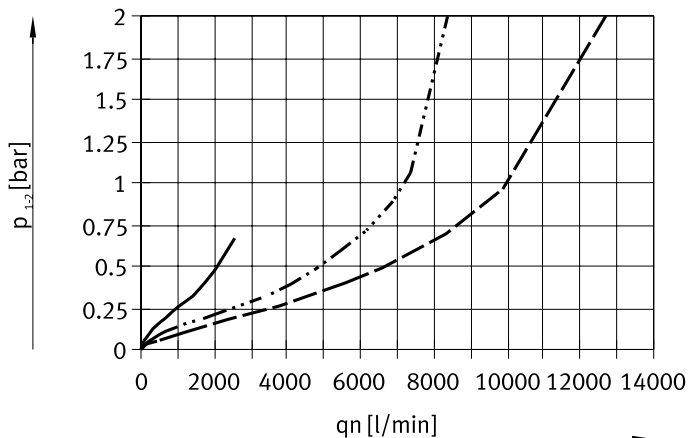

Datasheet

Dimensions – Basic version

Download CAD data → [www.festo.com](http://www.festo.com)

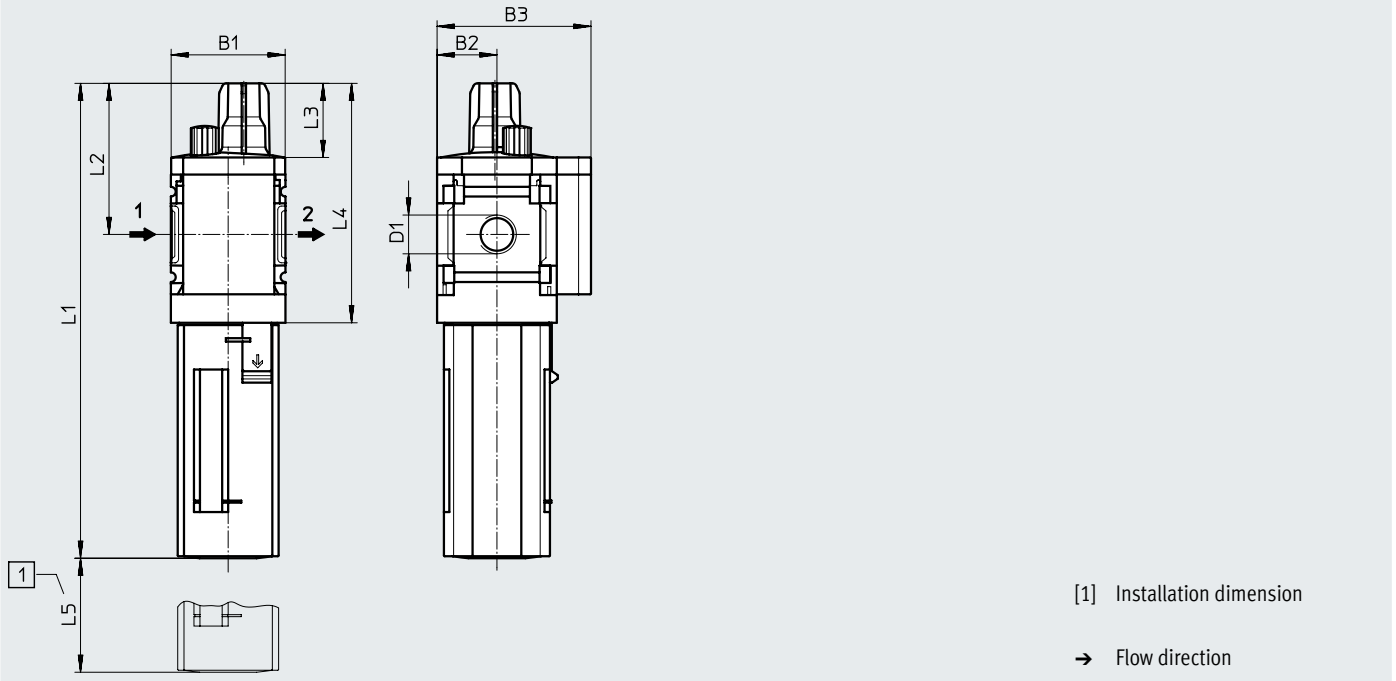

Type	B1	B2	B3	D1	L1 Bowl guard		L2	L3	L4	L5
					Plastic	Metal				
MS4-LOE-1/8	42	21	54	G1/8	166.6	184.9	53	26	84.5	80
MS4-LOE-1/4				G1/4						
MS6-LOE-1/4	62	31	76	G1/4	218	223	66	27	112	130
MS6-LOE-3/8				G3/8						
MS6-LOE-1/2				G1/2						

Note: This product conforms to ISO 1179-1 and ISO 228-1.

Ordering data

Size	Connection	Flow direction	Part no.	Type
<b>Plastic bowl guard</b>				
MS4	G1/8	From left to right	529413	MS4-LOE-1/8-R
	G1/4	From left to right	529411	MS4-LOE-1/4-R
MS6	G1/4	From left to right	529779	MS6-LOE-1/4-R
	G3/8	From left to right	529783	MS6-LOE-3/8-R
	G1/2	From left to right	529775	MS6-LOE-1/2-R
		From right to left	529776	MS6-LOE-1/2-R-Z
<b>Metal bowl</b>				
MS4	G1/4	From left to right	535790	MS4-LOE-1/4-U
MS6	G1/4	From left to right	529781	MS6-LOE-1/4-U
	G3/8	From left to right	529785	MS6-LOE-3/8-U
	G1/2	From left to right	529777	MS6-LOE-1/2-U

## Ordering data – Modular product system

Ordering table						
Grid dimension	[mm]	40	62	Conditions	Code	Enter code
Module no.		<b>527701</b>	<b>527674</b>			
Series		Standard			<b>MS</b>	MS
Size		4	6		...	
Function		Lubricators			<b>-LOE</b>	-LOE
Pneumatic connection	Female thread G1/8	–		[1]	<b>-1/8</b>	
	Female thread G1/4	Female thread G1/4		[1]	<b>-1/4</b>	
	–	Female thread G3/8		[1]	<b>-3/8</b>	
	–	Female thread G1/2		[1]	<b>-1/2</b>	
	Connecting plate G1/8	–			<b>-AGA</b>	
	Connecting plate G1/4	Connecting plate G1/4			<b>-AGB</b>	
	Connecting plate G3/8	Connecting plate G3/8			<b>-AGC</b>	
	–	Connecting plate G1/2			<b>-AGD</b>	
	–	Connecting plate G3/4			<b>-AGE</b>	
	Connecting plate 1/8 NPT	–		[1]	<b>-AQK</b>	
	Connecting plate 1/4 NPT	Connecting plate 1/4 NPT		[1]	<b>-AQN</b>	
	Connecting plate 3/8 NPT	Connecting plate 3/8 NPT		[1]	<b>-AQP</b>	
	–	Connecting plate 1/2 NPT		[1]	<b>-AQR</b>	
	–	Connecting plate 3/4 NPT		[1]	<b>-AQS</b>	
Bowl	Plastic bowl with plastic bowl guard				<b>-R</b>	
	Metal bowl				<b>-U</b>	
Type of mounting	Without mounting bracket					
	Mounting bracket standard design			[2]	<b>-WP</b>	
	Mounting bracket for hooking in service unit components			[1] [2]	<b>-WPM</b>	
	Mounting bracket centrally at rear (wall mounting top and bottom), connecting plates not required				<b>-WB</b>	
	Mounting bracket centrally at rear (wall mounting top), connecting plates not required	–			<b>-WBM</b>	
EU certification	None					
	II 2GD to EU Explosion Protection Directive (ATEX)				<b>-EX4</b>	
UL certification	None					
	cULus, ordinary location for Canada and USA				<b>-UL1</b>	
Flow direction	Flow direction from left to right					
	Flow direction from right to left				<b>-Z</b>	

[1] 1/8, 1/4, 3/8, 1/2, AQK, AQN, AQP, AQR, AQS, WPM Not with EU EX4 certification.

[2] WP, WPM Only with connecting plate AGA, AGB, AGC, AGD, AGE, AQK, AQN, AQP, AQR or AQS.

Peripherals overview

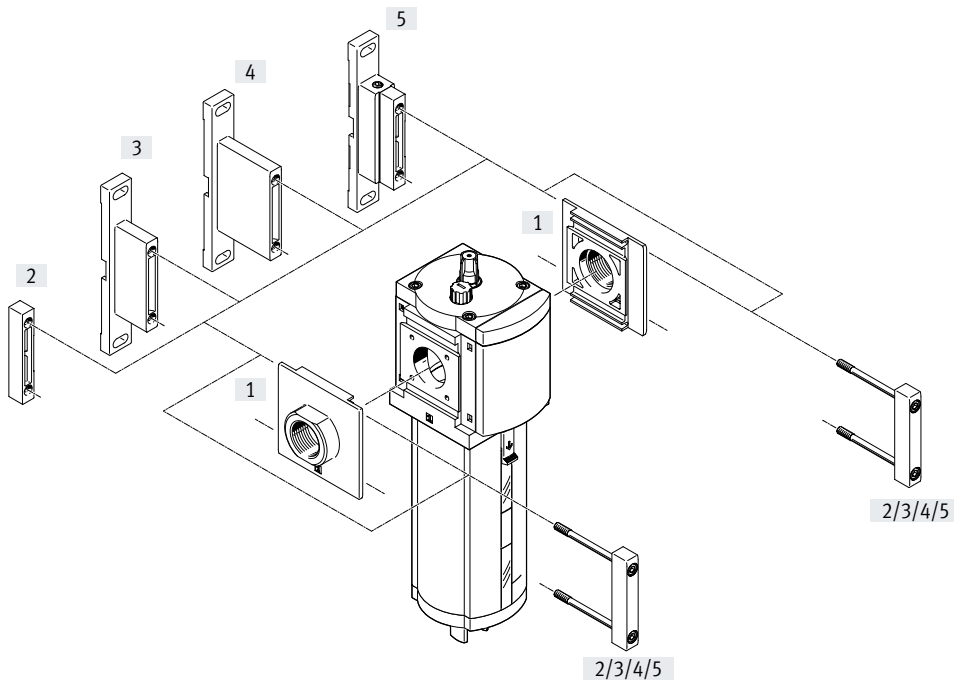

**Note**  
 Additional accessories:  
 • Module connector for combination with size MS6, MS9 or MS12  
 → Internet: rmv, armv

Mounting attachments and accessories		Individual device		Combination	→ Page/ Internet
		With female thread	With connecting plate	Module without connecting thread, without connecting plate	
[1]	Connecting plate SET MS9-AG...	–	■	■	ms9-ag
	Connecting plate SET MS9-AQ..	–	■	■	ms9-aq
[2]	Module connector MS9-MV	–	–	■	ms9-mv
[3]	Mounting bracket MS9-WP	■	■	■	ms9-wp
[4]	Mounting bracket MS9-WPB	■	■	■	ms9-wp
[5]	Mounting bracket MS9-WPM	■	■	■	ms9-wp

## Type codes

001	Series
<b>MS</b>	MS series

002	Size
<b>9</b>	Grid dimension 90 mm

003	Function
<b>LOE</b>	Compressed air lubricator

004	Pneumatic connection
<b>3/4</b>	Female thread G3/4
<b>1</b>	Female thread G1
<b>AGD</b>	Sub-base G1/2
<b>AGE</b>	Sub-base G3/4
<b>AGF</b>	Sub-base G1
<b>AGG</b>	Sub-base G1 1/4
<b>AGH</b>	Sub-base G1 1/2
<b>N3/4</b>	Female thread 3/4 NPT
<b>N1</b>	Female thread 1 NPT
<b>AQR</b>	Sub-base 1/2 NPT
<b>AQS</b>	Sub-base 3/4 NPT
<b>AQT</b>	Sub-base 1 NPT
<b>AQU</b>	Sub-base 1 1/4 NPT
<b>AQV</b>	Sub-base 1 1/2 NPT
<b>G</b>	Module without connecting thread, without sub-base

005	Bowl type
<b>U</b>	Metal bowl

006	Type of mounting
	Without mounting bracket
<b>WP</b>	Mounting bracket basic design
<b>WPM</b>	Mounting bracket for hooking in service unit components
<b>WPB</b>	Mounting bracket for large wall gap

007	UL certification
	None
<b>UL1</b>	cULus ordinary location for Canada and USA





008	Flow direction
	Flow direction from left to right
<b>Z</b>	Flow direction from right to left

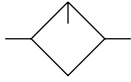

## Datasheet

### Function



-  - Flow rate  
8500 ... 27000 l/min
-  - Temperature range  
-10 ... +60°C
-  - Operating pressure  
1 ... 16 bar
-  - Spare parts management



The proportional lubricator adds a precisely adjustable amount of oil to the compressed air.

The pressure drop that occurs when air flows through a Venturi nozzle is used to feed oil from the reservoir to the drip cap.

From here, the oil drips into the air duct directly behind the proportional valve, where it is atomised. The amount of oil mist is proportional to the compressed air flow rate.

- Proportional lubricator with precision oil metering
- Integrated sintered filter for filtering the oil
- Reduces wear on drive units subject to high loads
- High flow rate
- Quick and easy oil top-up even during operation (under pressure)

The following oils are recommended for Festo components:  
Viscosity range to ISO 3448, ISO class VG 32

32 mm<sup>2</sup>/s (= cSt) at 40 °C

- Festo special oil OFSW-32 → 29
- Castrol HySpin ZZ 32
- BP Energol HLP 32
- Mobil Nuto H 32
- Mobil DTE 24
- Shell Tellus S2 MA 32

### General technical data

Pneumatic connection 1, 2		
Female thread		G3/4, G1, 3/4 NPT or 1 NPT
Connecting plate	[AG...]	G1/2, G3/4, G1, G1 1/4 or G1 1/2
	[AQ...]	1/2 NPT, 3/4 NPT, 1 NPT, 1 1/4 NPT or 1 1/2 NPT
Module without connecting thread/connecting plate	[G]	–
Design	Proportional standard mist lubricator	
Type of mounting	Via accessories	
	In-line installation	
Mounting position	Vertical ±5°	
Bowl guard	Integrated as metal bowl	
Minimum flow rate for lubricator function	[l/min]	100
Max. oil capacity	[ml]	490

† Note: This product conforms to ISO 1179-1 and ISO 228-1.

### Standard nominal flow rate $q_{nN}^{1)}$ [l/min]

Pneumatic connection 1, 2	G1/2, 1/2 NPT	G3/4, 3/4 NPT	G1, 1 NPT	G1 1/4, 1 1/4 NPT	G1 1/2, 1 1/2 NPT
In main flow direction 1 > 2	8500	15000	23000	26000	27000

1) Measured at  $p_1 = 6$  bar and  $\Delta p = 1$  bar.

## Datasheet

Operating and environmental conditions		
Operating pressure	[bar]	1 ... 16
Operating medium		Compressed air to ISO 8573-1:2010 [7:4:4]
		Inert gases
Ambient temperature	[°C]	-10 ... +60
Temperature of medium	[°C]	-10 ... +60
Storage temperature	[°C]	-10 ... +60
Corrosion resistance class CRC <sup>1)</sup>		2
UL certification <sup>2)</sup>		c UL us - Recognized (OL)

1) More information [www.festo.com/x/topic/crc](http://www.festo.com/x/topic/crc)

2) More information: [www.festo.com/catalogue/ms-loe](http://www.festo.com/catalogue/ms-loe) → Support/Downloads.

ATEX	
EU certification	[EX4]
ATEX category for gas	II 2G
Type of (ignition) protection for gas	Ex h IIC T6 Gb X
ATEX category for dust	II 2D
Type of (ignition) protection for dust	Ex h IIIC T60°C Db X
Explosion ambient temperature	-10°C ≤ Ta ≤ +60°C

Weight [g]	
Lubricators	2000

### Materials

#### Sectional view

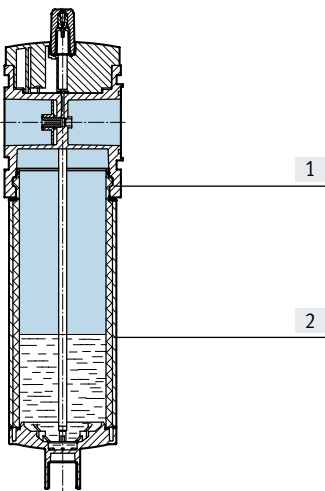

Lubricators		
[1]	Housing	Die-cast aluminium
[2]	Bowl	Wrought aluminium alloy
	Inspection window	PA
-	Covering	Reinforced PA
-	Connecting plate, module connector, mounting bracket	Die-cast aluminium
-	Seals	NBR
Note on materials		RoHS-compliant
LABS (PWIS) conformity		VDMA24364-B1/B2-L

Datasheet

Standard flow rate  $q_n$  as a function of differential pressure  $p_{1-2}$

Pneumatic connection G3/4, 3/4 NPT

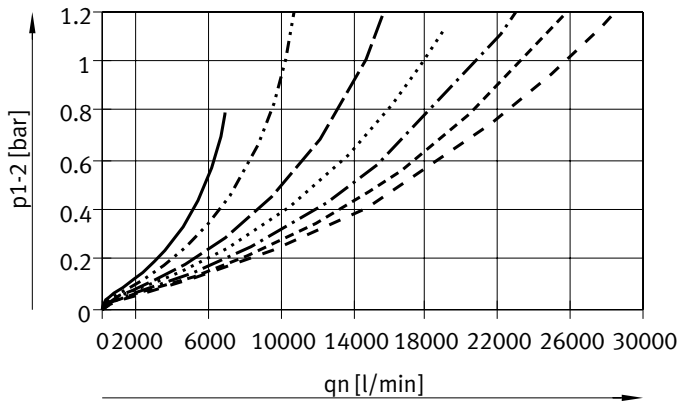

Pneumatic connection G1, 1 NPT

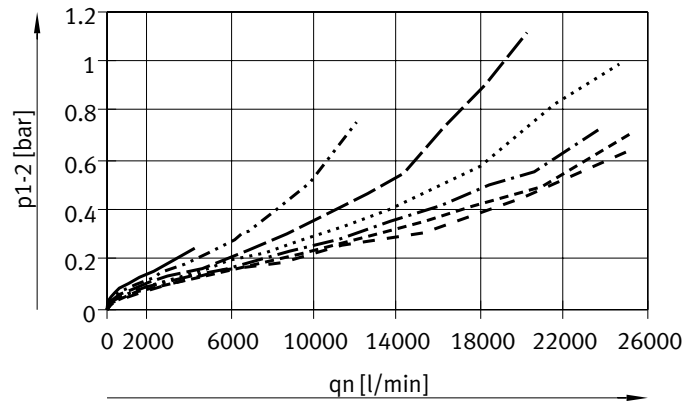

- 1 bar
- ..... 2 bar
- 4 bar
- .-. 6 bar
- .-.- 8 bar
- .-.-.- 10 bar
- .-.-.-.- 12 bar

Dimensions – Basic version

Download CAD data → [www.festo.com](http://www.festo.com)

[G] Module without connecting thread, without connecting plate

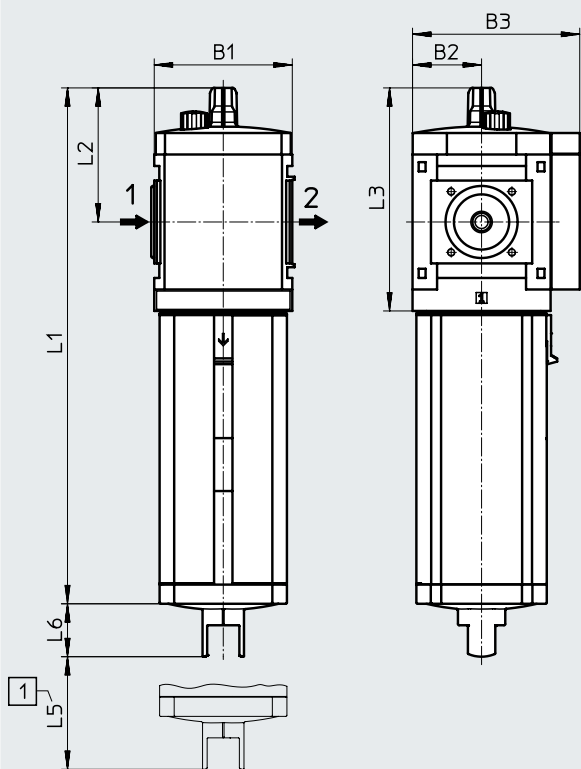

[1] Installation dimension

→ Flow direction

Type	B1	B2	B3	L1	L2	L3	L5 min.	L6
MS9-LOE-G	90	45	109	336.3	87	145	225	34.5

Datasheet

Dimensions – Female thread/connecting plate

Download CAD data → [www.festo.com](http://www.festo.com)

[3/4]/[1]/[N3/4]/[N1] Female thread

[AG...]/[AQ...] Connecting plate

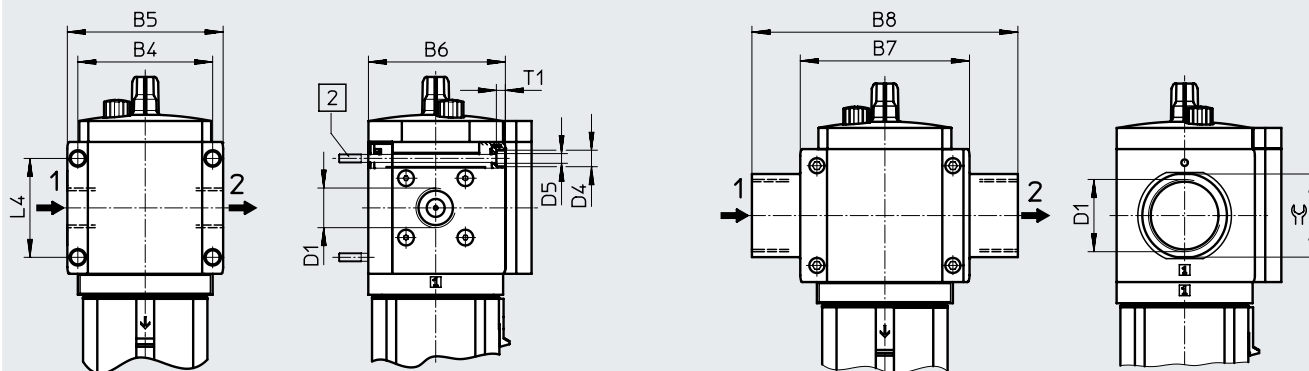

[2] Retaining screw M6xmin. 90 to DIN 912 (not included in the scope of delivery) for wall mounting without mounting bracket

→ Flow direction

Type	B4	B5	B6	B7	B8	D1	D4 ∅	D5 ∅	L4	T1	☞
MS9-LOE-3/4	90	104	91.5	-	-	G3/4	11	6.5	66	6	-
MS9-LOE-1						G1					
MS9-LOE-AGD	-	-	-	112	132	G1/2	-	-	-	-	30
MS9-LOE-AGE					132	G3/4					36
MS9-LOE-AGF					142	G1					41
MS9-LOE-AGG					162	G1 1/4					50
MS9-LOE-AGH					176	G1 1/2					55
MS9-LOE-N3/4	90	104	91.5	-	-	3/4 NPT	11	6.5	66	6	-
MS9-LOE-N1						1 NPT					
MS9-LOE-AQR	-	-	-	112	132	1/2 NPT	-	-	-	-	30
MS9-LOE-AQS					132	3/4 NPT					36
MS9-LOE-AQT					142	1 NPT					41
MS9-LOE-AQU					162	1 1/4 NPT					50
MS9-LOE-AQV					176	1 1/2 NPT					55

Note: This product conforms to ISO 1179-1 and ISO 228-1.

Ordering data

Size	Connection	Flow direction	Part no.	Type
<b>Metal bowl</b>				
MS9	Without connecting thread	From left to right	564144	MS9-LOE-G-U

## Ordering data – Modular product system

Ordering table		Grid dimension	[mm]	90	Conditions	Code	Enter code
Module no.		<b>562533</b>					
Series		Standard service unit				<b>MS</b>	MS
Size		9				<b>9</b>	9
Function		Lubricators				<b>-LOE</b>	-LOE
Pneumatic connection	Female thread G3/4			[1]		<b>-3/4</b>	
	Female thread G1			[1]		<b>-1</b>	
	Connecting plate G1/2					<b>-AGD</b>	
	Connecting plate G3/4					<b>-AGE</b>	
	Connecting plate G1					<b>-AGF</b>	
	Connecting plate G1 1/4					<b>-AGG</b>	
	Connecting plate G1 1/2					<b>-AGH</b>	
	Female thread 3/4 NPT			[1]		<b>-N3/4</b>	
	Female thread 1 NPT			[1]		<b>-N1</b>	
	Connecting plate 1/2 NPT			[1]		<b>-AQR</b>	
	Connecting plate 3/4 NPT			[1]		<b>-AQS</b>	
	Connecting plate 1 NPT			[1]		<b>-AQT</b>	
	Connecting plate 1 1/4 NPT			[1]		<b>-AQU</b>	
	Connecting plate 1 1/2 NPT			[1]		<b>-AQV</b>	
	Module without connecting thread, without connecting plate			[1]		<b>-G</b>	
Bowl		Metal bowl				<b>-U</b>	-U
Type of mounting	Without mounting bracket						
	Mounting bracket standard design			[2]		<b>-WP</b>	
	Mounting bracket for hooking in service unit components			[2]		<b>-WPM</b>	
	Mounting bracket for large wall gap			[2]		<b>-WPB</b>	
EU certification	None						
	II 2GD in accordance with EU Directive 94/9/EC					<b>-EX4</b>	
UL certification	None						
	cULus, ordinary location for Canada and USA					<b>-UL1</b>	
Flow direction	Flow direction from left to right						
	Flow direction from right to left					<b>-Z</b>	

[1] 3/4, 1, N3/4, N1, AQR, Not with EX4  
AQS, AQT, AQU, AQV, G

[2] WP, WPM, WPB Not with pneumatic connection G.

## Peripherals overview

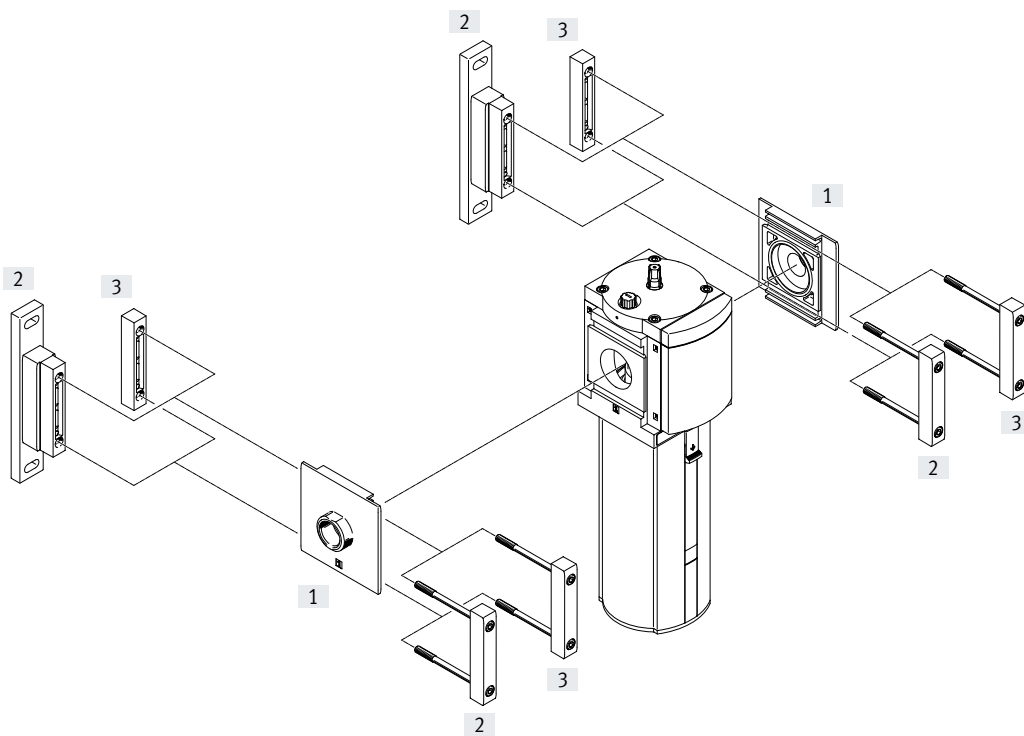

-  - **Note**  
 Additional accessories:  
 • Module connector for combination with size MS9  
 → Internet: armv

Mounting attachments and accessories		→ Page/ Internet
[1]	Connecting plate SET MS12-AG...	ms12-ag
[2]	Mounting bracket MS12-WP	ms12-wp
[3]	Module connector MS12-MV	ms12-mv

## Type codes





001	Series
<b>MS</b>	MS series
002	Size
<b>12</b>	Grid dimension 124 mm
003	Function
<b>LOE</b>	Compressed air lubricator
004	Pneumatic connection
<b>AGF</b>	Sub-base G1
<b>AGG</b>	Sub-base G1 1/4
<b>AGH</b>	Sub-base G1 1/2
<b>AGI</b>	Sub-base G2
<b>G</b>	Module without connecting thread, without sub-base

005	Bowl type
<b>U</b>	Metal bowl
006	Type of mounting
	Without mounting bracket
<b>WP</b>	Mounting bracket basic design
007	Flow direction
	Flow direction from left to right
<b>Z</b>	Flow direction from right to left

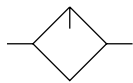
## Datasheet

### Function



-  - Flow rate  
20000 ... 22000 l/min
-  - Temperature range  
0 ... 60°C
-  - Operating pressure  
1 ... 16 bar
-  - Spare parts management



The proportional lubricator adds a precisely adjustable amount of oil to the compressed air.

The pressure drop that occurs when air flows through a Venturi nozzle is used to feed oil from the reservoir to the drip cap.

From here, the oil drips into the air duct directly behind the proportional valve, where it is atomised. The amount of oil mist is proportional to the compressed air flow rate.

- Proportional lubricator with precision oil metering
- Reduces wear on drive units subject to high loads
- High flow rate
- Quick and easy oil top-up even during operation (under pressure)

The following oils are recommended for Festo components:

Viscosity range to ISO 3448, ISO class VG 32

32 mm<sup>2</sup>/s (= cSt) at 40 °C

- Festo special oil OFSW-32 → 29
- Castrol HySpin ZZ 32
- BP Energol HLP 32
- Mobil Nuto H 32
- Mobil DTE 24
- Shell Tellus S2 MA 32

### General technical data

Pneumatic connection 1, 2		
Connecting plate [AG...]		G1, G1 1/4, G1 1/2 or G2
Module without connecting thread/connecting plate [G]		–
Design	Proportional standard mist lubricator	
Type of mounting	Via accessories	
	In-line installation	
Mounting position	Vertical ±5°	
Bowl guard	Metal bowl	
Minimum flow rate for lubricator function [l/min]	400	
Max. oil capacity [cm <sup>3</sup> ]	1500	

† Note: This product conforms to ISO 1179-1 and ISO 228-1.

### Standard nominal flow rate q<sub>nN</sub><sup>1)</sup> [l/min]

Pneumatic connection 1, 2	G1	G1 1/4	G1 1/2	G2
In main flow direction 1 > 2	20000	20500	21000	22000

1) Dependent on the selected connecting plate; must be ordered separately as an accessory → Internet: ms12-ag  
Measured at p<sub>1</sub> = 6 bar and Δp = 0.5 bar



## Datasheet

Operating and environmental conditions		
Operating pressure	[bar]	1 ... 16
Operating medium		Compressed air to ISO 8573-1:2010 [7:4:4]
Ambient temperature	[°C]	0 ... +60
Temperature of medium	[°C]	0 ... +60
Storage temperature	[°C]	-10 ... +60
Corrosion resistance class CRC <sup>1)</sup>		2

1) More information [www.festo.com/x/topic/crc](http://www.festo.com/x/topic/crc)

Weight [g]	
Lubricator with metal bowl	6500

### Materials

Sectional view

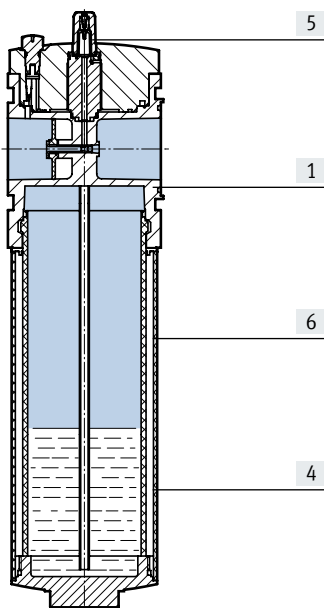

Lubricators		
[1]	Housing	Die-cast aluminium
[4]	Metal bowl	Aluminium
[5]	Lubricator dome	PC
[6]	Metal bowl sight glass	PA
-	Seals	NBR

## Datasheet

### Standard flow rate $q_n$ as a function of differential pressure $\Delta p_{1-2}$

Pneumatic connection G1 with connecting plate MS12-AGF

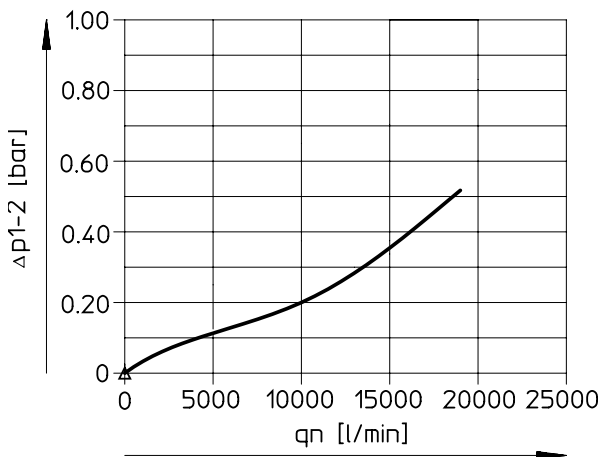

Pneumatic connection G1 1/4 with connecting plate MS12-AGG

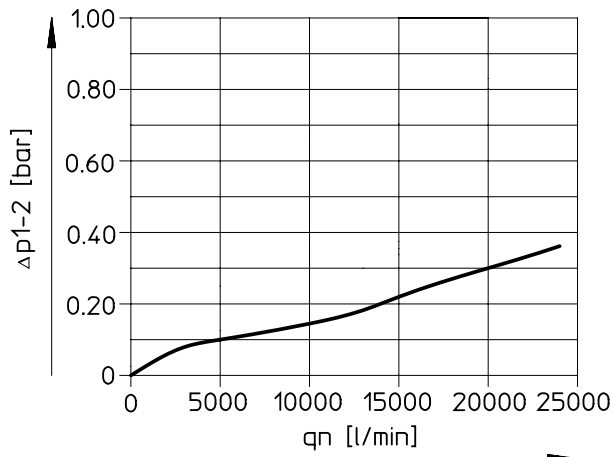

Pneumatic connection G1 1/2 with connecting plate MS12-AGH

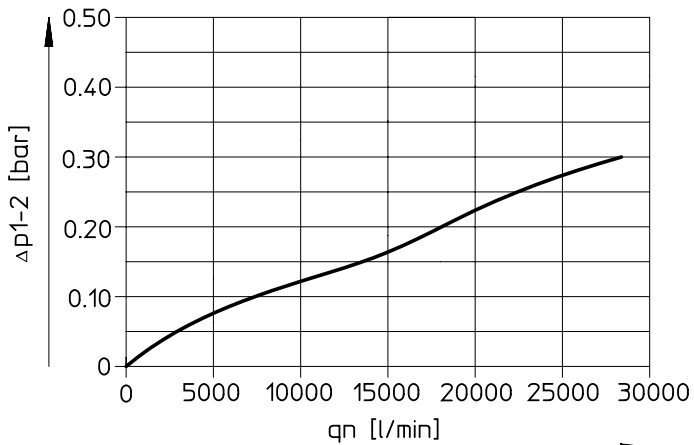

Pneumatic connection G2 with connecting plate MS12-AGI

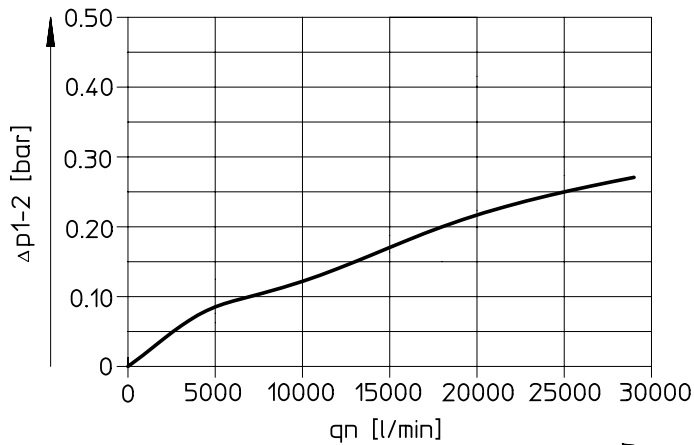

Datasheet

Dimensions – Basic version

Download CAD data → [www.festo.com](http://www.festo.com)

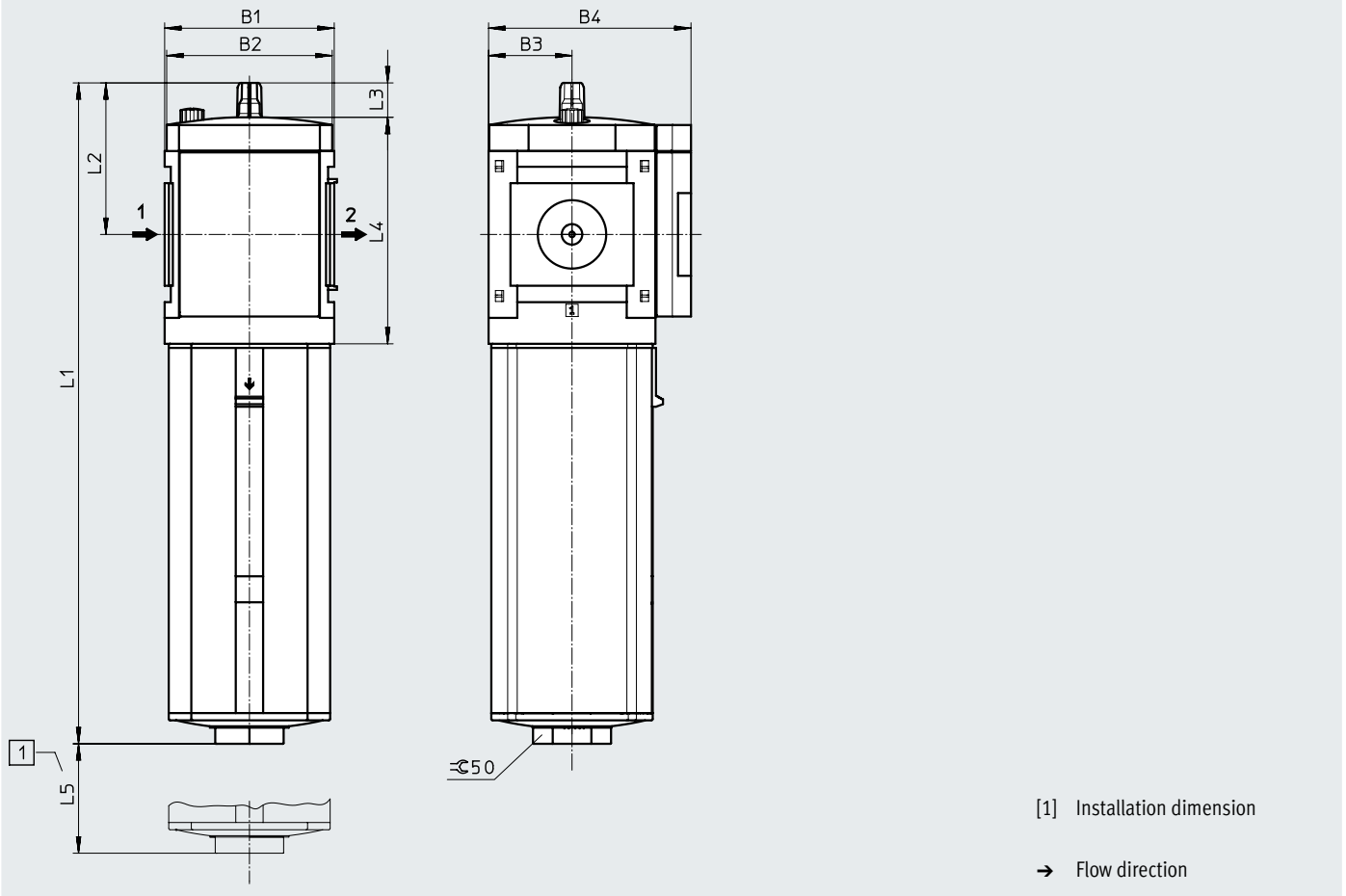

Type	B1	B2	B3	B4	L1	L2	L3	L4	L5
MS12-LOE	124	122	61	148	483	111	25	166	300

Ordering data

Size	Connection	Flow direction	Part no.	Type
<b>Metal bowl</b>				
MS12	Without connecting thread	From left to right	537156	MS12-LOE-G-U

## Ordering data – Modular product system

Ordering table		Grid dimension	[mm]	124	Conditions	Code	Enter code
Module no.		<b>535041</b>					
Series		Standard				<b>MS</b>	MS
Size		12				<b>12</b>	12
Function		Lubricators				<b>-LOE</b>	-LOE
Pneumatic connection	Connecting plate G1					<b>-AGF</b>	
	Connecting plate G1 1/4					<b>-AGG</b>	
	Connecting plate G1 1/2					<b>-AGH</b>	
	Connecting plate G2					<b>-AGI</b>	
	Module without connecting thread, without connecting plate					<b>-G</b>	
Bowl		Metal bowl				<b>-U</b>	-U
Type of mounting	Without mounting bracket						
	Mounting bracket standard design				[1]	<b>-WP</b>	
Flow direction	Flow direction from left to right						
	Flow direction from right to left					<b>-Z</b>	

[1] WP Only with connecting plate AGF, AGG, AGH or AGI.

## Accessories

## Special oil OFSW



## Ordering data

Scope of delivery

Part no.

Type

1 litre

152811

OFSW-32