

One-way flow control valves VFOE

FESTO



Festo Core Range
Solves the majority of your automation tasks







Worldwide: Quickest delivery – wherever, whenever
Simply good: Expected high Festo quality
Fast: Easy and fast to select

With the Festo Core Range, we have selected the most important products and functions from our broad product catalogue, and added the quickest delivery.

The Core Range offers you the best value for your automation tasks.

Just look
for the
star!





Product range overview – One-way flow control valves

Version	Valve function	Version	Type	Outlet direction of connection	Pneumatic connection 1	Pneumatic connection 2	qnN ¹⁾ [l/min]	Adjusting element	→ Page/Internet	
Standard										
Polymer										
Exhaust air one-way flow control function		VFOE-LE	Elbow outlet	QS-4, QS-6, QS-8, QS-10, QS-12	M5, G1/8, G1/4, G3/8, G1/2, R1/8, R1/4, R3/8, R1/2	90 ... 1200	Rotary knob with detent	6		
		GRLA	Elbow outlet	QS-6, QS-8	G1/8, G1/4, G3/8	520 ... 650	Knurled screw	grla		
Supply air one-way flow control function		VFOE-LS	Elbow outlet	QS-4, QS-6, QS-8	M5, M7, G1/8, R1/8	90 ... 180	Rotary knob with detent	6		
Metal										
Exhaust air one-way flow control function		GRLA	Elbow outlet	QS-3, QS-4, QS-6, QS-8, QS-10, QS-12	M5, G1/8, G1/4, G3/8, G1/2	100 ... 1580	Slotted head screw Knurled screw	grla		
					M5, G1/8, G1/4, G3/8, G1/2, G3/4	M5, G1/8, G1/4, G3/8, G1/2, G3/4	95 ... 4320		Slotted head screw	grla
					M5, G1/8, G1/4	M5, G1/8, G1/4	95 ... 610		Knurled screw	
		GRLSA	Elbow outlet	QS-6, QS-8	G1/8, G1/4	0 ... 450	Rotary knob with scale, internal hex	grlsa		
									PK-3, PK-4, PK-6	M5, G1/8, G1/4
Supply air one-way flow control function		GRLZ	Elbow outlet	QS-3, QS-4, QS-6, QS-8	M5, G1/8	100 ... 215	Slotted head screw	grlz		
					M5, G1/8, G1/4	M5, G1/8, G1/4	95 ... 610		Slotted head screw Knurled screw	grlz
					PK-3, PK-4, PK-6	M5, G1/8, G1/4	83 ... 540		Slotted head screw	
		VFOC-S	Elbow outlet	QS-4, QS-6	Push-in sleeve ²⁾ QS-4, QS-6	0 ... 270	Slotted head screw	vfoc		
									Nickel-plated metal	
Exhaust air one-way flow control function		VFOH-LE	Elbow outlet	QS-4, QS-6, QS-8, QS-10	G1/8, G1/4	180 ... 530	External hex	vfoh		

1) Standard nominal flow rate in flow control direction.

2) Only suitable for push-in connector QS.

Product range overview – One-way flow control valves

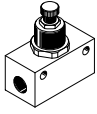
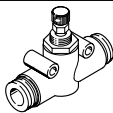
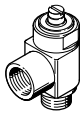
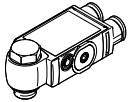
Version	Valve function	Version	Type	Outlet direction of connection	Pneumatic connection 1	Pneumatic connection 2	qnN ¹⁾ [l/min]	Adjusting element	→ Page/ Internet
Mini	Exhaust air one-way flow control function		GRLA	Elbow outlet	QS-3, QS-4	M3, M5	40 ... 41	Slotted head screw	grla
					M3	M3	0 ... 18	Slotted head screw	grla
	Supply air one-way flow control function		GRLZ	Elbow outlet	QS-3, QS-4	M3, M5	41 ... 48	Slotted head screw	grlz
					M3	M3	0 ... 18	Slotted head screw	grlz
In-line installation	One-way flow control function		GR/GRA	Straight	M3, M5, G1/8, G1/4, G3/8, G1/2, G3/4	M3, M5, G1/8, G1/4, G3/8, G1/2, G3/4	29.5 ... 3300	Knurled screw	gr
			GR	Straight	QS-3, QS-4, QS-6, QS-8	QS-3, QS-4, QS-6, QS-8	85 ... 265	Knurled screw	gr
Corrosion-resistant	Exhaust air one-way flow control function		CRGRLA	Elbow outlet	M5, G1/8, G1/4, G3/8, G1/2	M5, G1/8, G1/4, G3/8, G1/2	95 ... 2100	Slotted head screw	crgrla
			VFOF	Elbow outlet	QS-6, QS-8	G1/8, G1/4	240 ... 590	Internal hex	vfof

1) Standard nominal flow rate in flow control direction.

Key features

Which fitting fits which thread?

Metric thread

- Threads are comparable with G threads and are fitted as cylindrical metric thread
- Sealing is guaranteed as the O-ring sits in a groove that seals against the tube.

G thread to ISO 228-1

- Shorter thread
- Constant installation depth
- Replaceable sealing ring
- Sealing on front face
- Can be re-used a number of times thanks to replaceable sealing ring.

R thread to EN 10226-1 and ISO 7/1

- Self-sealing thread
- Sealing via coated threads
- No additional sealing surface required
- Smaller installation dimensions since there is no need for an offset for the sealing surface
- Can be reused up to 5 times.

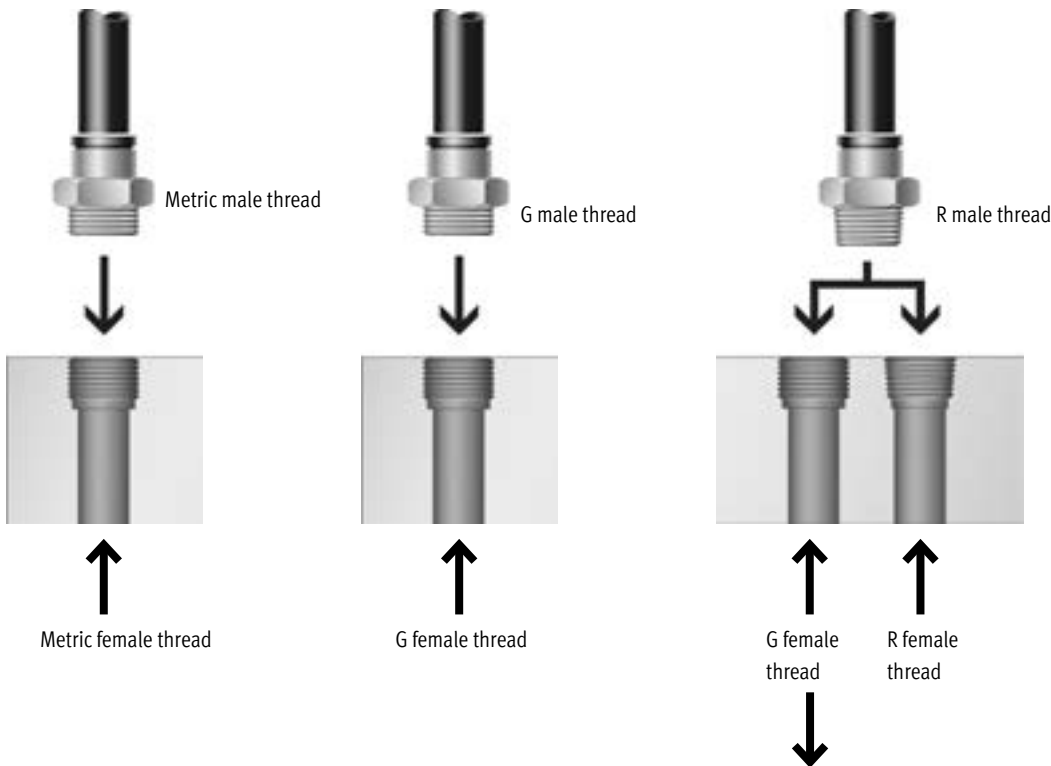

 **Note**
 If R male threads are combined with G female threads, leakage can occur if the G female thread was not manufactured cleanly or if it is not within permissible tolerances. In this case additional sealing, e.g. using a sealing band, is required.

 **Note**
 Contact between the assembly tool and the housing should be avoided during assembly.

 **Note**
 When re-installing the one-way flow control valves with R thread, we also recommend using sealing band.

Key features

For manufacturing lithium-ion batteries (F1A)

Recommended for production plants for manufacturing lithium-ion batteries.

Metals with copper, zinc or nickel as the main constituent are excluded from use.

Exceptions are nickel in steel, chemically nickel-plated surfaces, printed circuit boards, cables, electrical plug connectors and coils.



Note

Foreign particles can adhere to the product or arise during installation. Depending on the application, it may be necessary to purge the product with clean compressed air, to clean it after installation and to operate it with ducted exhaust air.

Type codes

001		Series
VFOE	One-way flow control valve	
002		Design
L	L-shape	
003		Function
E	One-way flow control valve for exhaust air	
S	One-way flow control valve for supply air	
004		Adjusting component
T	Rotary knob with detent	
005		Pneumatic connection 2
M5	M5	
M7	M7	
G18	G1/8	
G14	G1/4	
G38	G3/8	
G12	G1/2	
R18	R1/8	
R14	R1/4	
R38	R3/8	
R12	R1/2	

006		Pneumatic connection 1
Q4	Push-in connector 4 mm	
Q6	Push-in connector 6 mm	
Q8	Push-in connector 8 mm	
Q10	Push-in connector 10 mm	
Q12	Push-in connector 12 mm	
007		Special material properties
	None	
F1A	Recommended for production facilities for the manufacture of lithium-ion batteries	
008		Package unit
	Standard	
P20	20	
P50	50	

Datasheet

One-way flow control function

Exhaust air

Supply air

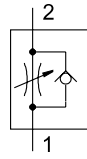
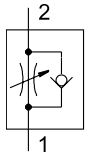

- Flow rate
82 ... 1300 l/min
- Temperature range
-10 ... +60°C
- Operating pressure
0.02 ... 1 MPa



General technical data – VFOE-LE

Pneumatic connection 2	M5	G1/8	G1/4	G3/8	G1/2	R1/8	R1/4	R3/8	R1/2	
Valve function	Exhaust air one-way flow control function									
Pneumatic connection 1	QS-4 QS-6	QS-4 QS-6 QS-8	QS-6 QS-8 QS-10	QS-8 QS-10	QS-12	QS-4 QS-6 QS-8	QS-6 QS-8 QS-10	QS-8 QS-10	QS-12	
Actuation type	Manual									
Mounting position	Any									
Adjusting element	Rotary knob with detent, colour: blue									
Type of mounting	Screw-in									
Suitability for re-installation	max.	-				5				
Rotatability	Can be rotated 360° around the screw-in axis after mounting / not permitted for continuous rotation									
Nominal tightening torque	[Nm]	2 ±20%	5 ±20%	10 ±20%	13 ±20%	23 ±20%	Hand-tight + 1 to 2 turns			
Max. tightening torque	[Nm]	2.4	6	12	15.6	27.6	-			

General technical data – VFOE-LS

Pneumatic connection 2	M5	M7	G1/8	R1/8	
Valve function	Supply air one-way flow control function				
Pneumatic connection 1	QS-4 QS-6	QS-4 QS-6	QS-4 QS-6 QS-8	QS-4 QS-6 QS-8	
Actuation type	Manual				
Mounting position	Any				
Adjusting element	Rotary knob with detent, colour: light blue				
Type of mounting	Screw-in				
Suitability for re-installation	max.	-		5	
Rotatability	Can be rotated 360° around the screw-in axis after mounting / not permitted for continuous rotation				
Nominal tightening torque	[Nm]	2 ±20%	3 ±20%	5 ±20%	Hand-tight + 1 to 2 turns
Max. tightening torque	[Nm]	2.4	3.6	6	-

Datasheet

Operating and environmental conditions		
Threaded bolt material ¹⁾		Galvanised steel Steel, chemically nickel-plated
Operating pressure for entire temperature range	[MPa]	0.02 ... 1
	[bar]	0.2 ... 10
	[psi]	2.9 ... 145
Operating medium		Compressed air to ISO 8573-1:2010 [7:4:4]
PWIS conformity		VDMA24364 zone III
Suitable for the production of lithium-ion batteries		– Metals with more than 1% by mass of copper, zinc or nickel are excluded from use. Exceptions are nickel in steel, chemically nickel-plated surfaces, printed circuit boards, cables, electrical plug connectors and coils
Cleanroom class		Class 4 to ISO 14644-1
Note on the operating/pilot medium		Lubricated operation possible (in which case lubricated operation will always be required)
Ambient temperature	[°C]	–10 ... +60
Temperature of medium	[°C]	–10 ... +60
Corrosion resistance class CRC ²⁾		1 - no corrosion stress 0 - Low corrosion stress
ATEX certification ³⁾		The information in the certificate must be observed! For zone 1, 2, 21, 22

1) Steel, chemically nickel-plated: suitable for battery production (VFOE...-F1A)

2) More information www.festo.com/x/topic/kbk

3) More information www.festo.com/catalogue/vfoe → Support/Downloads.

Materials	
Housing	PBT
Cover, releasing ring	PBT
Threaded bolt	Galvanised steel
Static seals	NBR
Dynamic seals	HNBR
Note on materials	RoHS-compliant

Datasheet

Standard nominal flow rate q_{nN} at 0.6 → 0.5 MPa as a function of spindle rotations n

Threaded connection M5 (exhaust air)

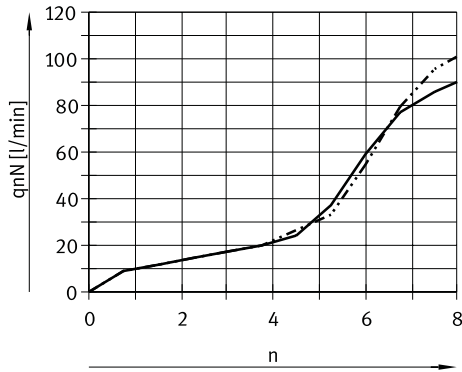

- Push-in connector 4 mm
- - - Push-in connector 6 mm

Standard flow rate q_n at 0.6 → 0 MPa as a function of spindle rotations n

Threaded connection M5 (exhaust air)

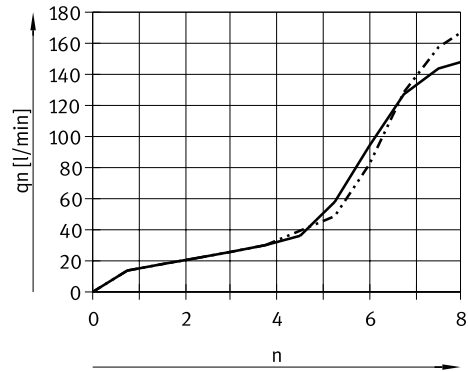

- Push-in connector 4 mm
- - - Push-in connector 6 mm

Threaded connection G1/8, R1/8 (exhaust air)

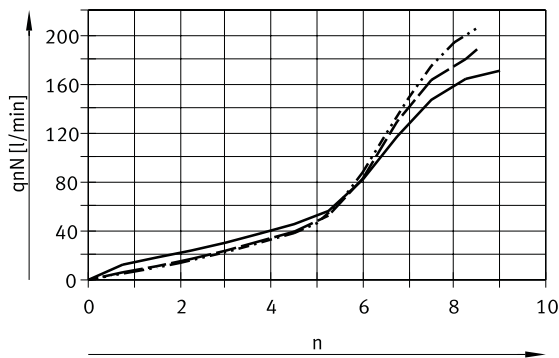

- Push-in connector 4 mm
- - - Push-in connector 6 mm
- · - Push-in connector 8 mm

Threaded connection G1/8, R1/8 (exhaust air)

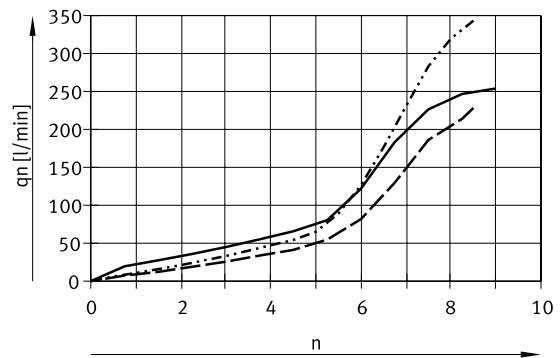

- Push-in connector 4 mm
- - - Push-in connector 6 mm
- · - Push-in connector 8 mm

Threaded connection G1/4, R1/4 (exhaust air)

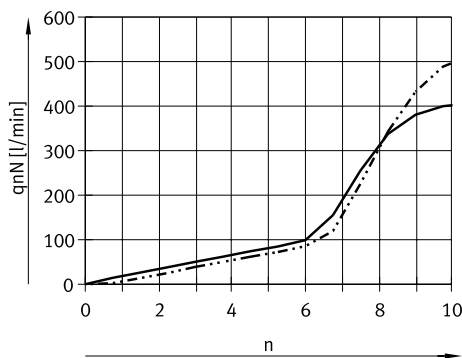

- Push-in connector 6 mm
- - - Push-in connector 8 mm / 10 mm

Threaded connection G1/4, R1/4 (exhaust air)

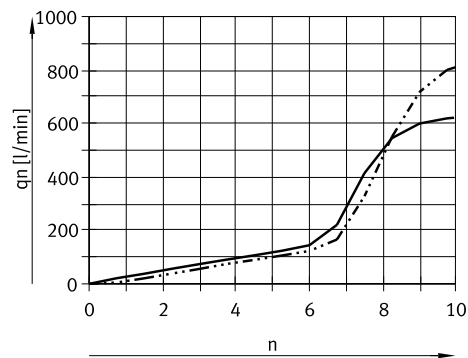

- Push-in connector 6 mm
- - - Push-in connector 8 mm / 10 mm

Datasheet

Standard nominal flow rate q_{nN} at 0.6 → 0.5 MPa as a function of spindle rotations n

Threaded connection G3/8, R3/8 (exhaust air)

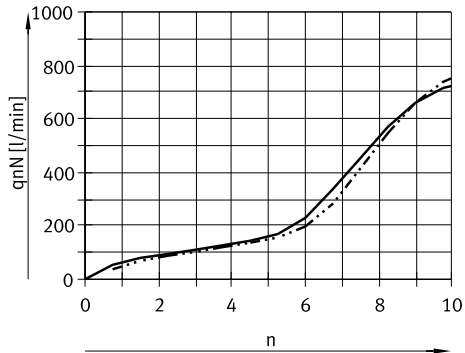

— Push-in connector 8 mm
 - - - - - Push-in connector 10 mm

Standard flow rate q_n at 0.6 → 0 MPa as a function of spindle rotations n

Threaded connection G3/8, R3/8 (exhaust air)

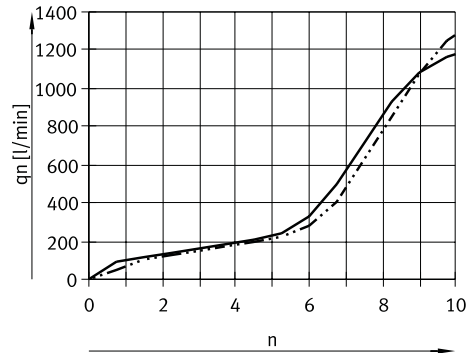

— Push-in connector 8 mm
 - - - - - Push-in connector 10 mm

Threaded connection G1/2, R1/2 (exhaust air)

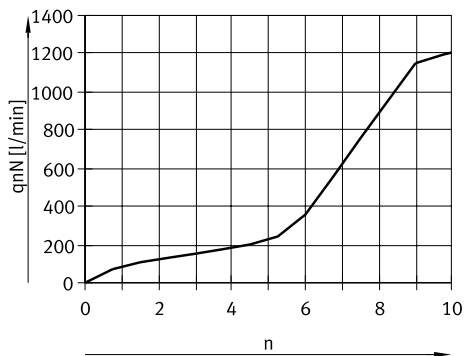

— Push-in connector 12 mm

Threaded connection G1/2, R1/2 (exhaust air)

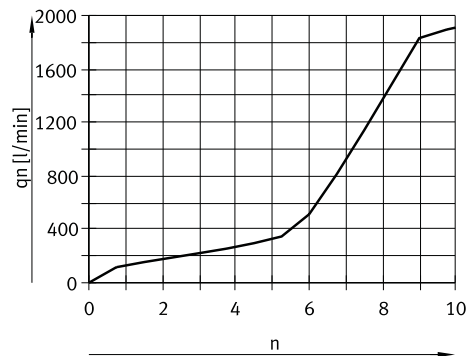

— Push-in connector 12 mm

Datasheet

Standard nominal flow rate q_{nN} at 0.6 → 0.5 MPa as a function of spindle rotations n

Threaded connection M5, M7 (supply air)

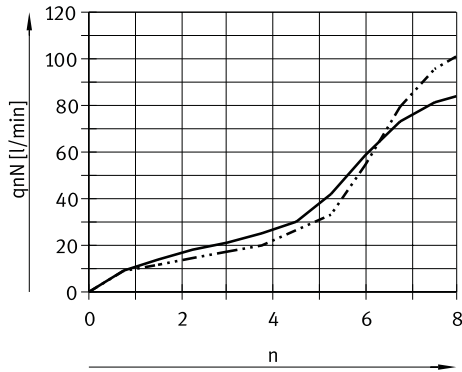

- Push-in connector 4 mm
- - - Push-in connector 6 mm

Standard flow rate q_n at 0.6 → 0 MPa as a function of spindle rotations n

Threaded connection M5, M7 (supply air)

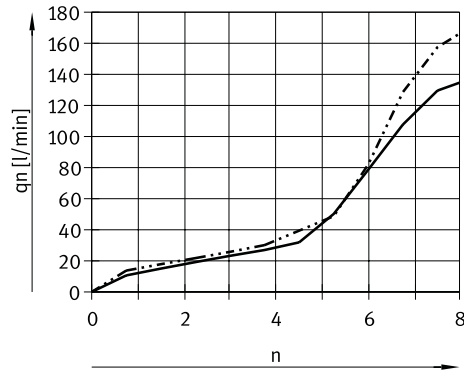

- Push-in connector 4 mm
- - - Push-in connector 6 mm

Threaded connection G1/8, R1/8 (supply air)

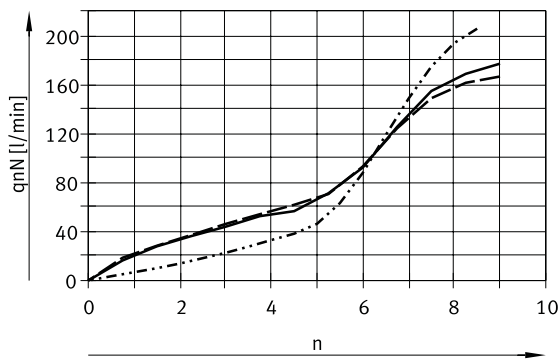

- Push-in connector 4 mm
- - - Push-in connector 6 mm
- · - Push-in connector 8 mm

Threaded connection G1/8, R1/8 (supply air)

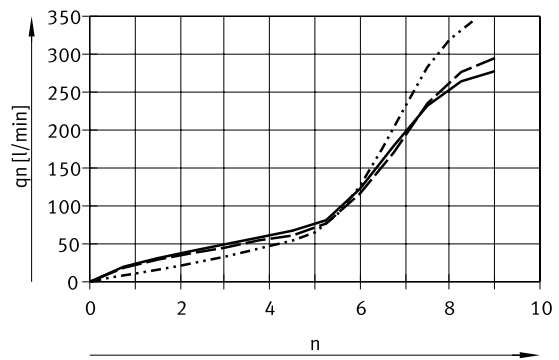

- Push-in connector 4 mm
- - - Push-in connector 6 mm
- · - Push-in connector 8 mm

Datasheet

Dimensions VFOE-...-M../G..

Download CAD data → www.festo.com

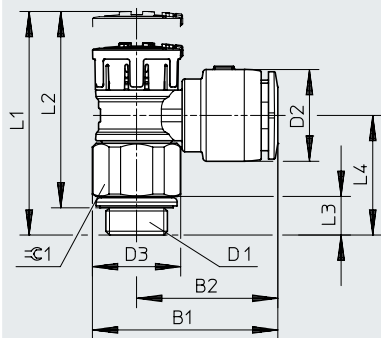

Type	B1	B2	D1	D2 ø	D3 ø	L1		L2		L3	L4	⌀ 1
						Unlocked (max.)	Locked (max.)	Unlocked (max.)	Locked (max.)			
VFOE-...-M5-Q4	19.6	14.6	M5	9	10	27.6	26.6	25	24	4.1	13.9	9
VFOE-...-M5-Q6	22.6	17.6	M5	11	10	27.6	26.6	25	24	4.1	13.9	9
VFOE-...-M7-Q4	19.6	14.6	M7	9	10	29.5	28.5	25	24	6	15.8	9
VFOE-...-M7-Q6	22.6	17.6	M7	11	10	29.5	28.5	25	24	6	15.8	9
VFOE-...-G18-Q4	23.3	16.3	G1/8	9	14	31.7	30.3	27.4	26	6.1	18.9	13
VFOE-...-G18-Q6	24.4	17.4	G1/8	11	14	31.7	30.3	27.4	26	6.1	18.9	13
VFOE-...-G18-Q8	29.3	22.3	G1/8	14.5	14	31.7	30.3	27.4	26	6.1	18.9	13
VFOE-...-G14-Q6	28.3	19.3	G1/4	11	17.9	38.6	36.7	33.9	32	7	22	16
VFOE-...-G14-Q8	30	21	G1/4	14.5	17.9	38.6	36.7	33.9	32	7	22	16
VFOE-...-G14-Q10	35.1	26.2	G1/4	16.5	17.9	38.6	36.7	33.9	32	7	22	16
VFOE-...-G38-Q8	34.5	23.3	G3/8	14.5	22.4	44.1	41.9	38.2	36	8.5	26.2	21
VFOE-...-G38-Q10	39.6	28.4	G3/8	17.5	22.4	44.1	41.9	38.2	36	8.5	26.2	21
VFOE-...-G12-Q12	46.8	33.3	G1/2	20.8	27	53.7	50.8	46.8	43.9	9.5	31	24

Dimensions VFOE-...-R..

Download CAD data → www.festo.com

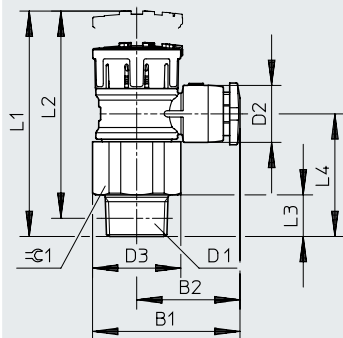

Type	B1	B2	D1	D2 ø	D3 ø	L1		L2		L3	L4	⌀ 1
						Unlocked (max.)	Locked (max.)	Unlocked (max.)	Locked (max.)			
VFOE-...-R18-Q4	23.3	16.3	R1/8	9	14	32.2	30.8	29.2	27.8	6.6	19.4	13
VFOE-...-R18-Q6	24.4	17.4	R1/8	11	14	32.2	30.8	29.2	27.8	6.6	19.4	13
VFOE-...-R18-Q8	29.3	22.3	R1/8	14.5	14	32.2	30.8	29.2	27.8	6.6	19.4	13
VFOE-...-R14-Q6	28.3	19.3	R1/4	11	17.9	41.2	39.3	36.7	34.8	10.1	25.1	16
VFOE-...-R14-Q8	30	21	R1/4	14.5	17.9	41.2	39.3	36.7	34.8	10.1	25.1	16
VFOE-...-R14-Q10	35.1	26.2	R1/4	17.5	17.9	41.2	39.3	36.7	34.8	10.1	25.1	16
VFOE-...-R38-Q8	34.5	23.3	R3/8	14.5	22.4	45.2	43	40.7	38.5	10.1	27.8	21
VFOE-...-R38-Q10	39.6	28.4	R3/8	17.5	22.4	45.2	43	40.7	38.8	10.1	27.8	21
VFOE-...-R12-Q12	46.8	33.3	R1/2	20.8	27	55.8	52.9	50.8	47.9	12.1	33.6	24

Datasheet

★ Core Range

Ordering data									
Pneumatic connection		Standard nominal flow rate q _N At 0.6 MPa → 0.5 MPa		Standard flow rate q _n At 0.6 MPa → 0 MPa		Weight	Part no.	Type	PU ¹⁾
2	1	In flow control direction [l/min]	In non-return direction [l/min]	In flow control direction [l/min]	In non-return direction [l/min]	[g]			
Exhaust air one-way flow control function									
M5	QS-4	90	50 ... 90	150	130 ... 160	3.3	8068723	VFOE-LE-T-M5-Q4	1
							8095432	VFOE-LE-T-M5-Q4-P50	50
	QS-6	105	60 ... 105	160	150 ... 180		8068724	VFOE-LE-T-M5-Q6	1
G1/8	QS-4	150	90 ... 150	250	240 ... 300	9.5	★ 8068725	VFOE-LE-T-G18-Q4	1
							★ 8068726	VFOE-LE-T-G18-Q6	1
	QS-6	165	110 ... 200	280	300 ... 360		8095433	VFOE-LE-T-G18-Q6-P50	50
G1/4	QS-8	170	130 ... 200	320	320 ... 390	16	★ 8068727	VFOE-LE-T-G18-Q8	1
							8068728	VFOE-LE-T-G14-Q6	1
	QS-6	400	350 ... 450	610	700 ... 800		8068729	VFOE-LE-T-G14-Q8	1
G1/2	QS-8	500	370 ... 500	810	750 ... 900	29.5	8095434	VFOE-LE-T-G14-Q8-P50	50
							8068730	VFOE-LE-T-G14-Q10	1
	QS-10	500	370 ... 500	810	750 ... 900				
G3/8	QS-8	720	600 ... 900	1150	1300 ... 1500	49.5	8068731	VFOE-LE-T-G38-Q8	1
							8068732	VFOE-LE-T-G38-Q10	1
	QS-10	750	700 ... 1000	1280	1400 ... 1600		8095435	VFOE-LE-T-G38-Q10-P20	20
G1/2	QS-12	1200	600 ... 1200	1900	1400 ... 2000	49.5	8068733	VFOE-LE-T-G12-Q12	1
							8095436	VFOE-LE-T-G12-Q12-P20	20
R1/8	QS-4	150	90 ... 150	250	240 ... 300	9.5	★ 8068734	VFOE-LE-T-R18-Q4	1
							★ 8068735	VFOE-LE-T-R18-Q6	1
	QS-6	165	110 ... 200	280	300 ... 360		★ 8068736	VFOE-LE-T-R18-Q8	1
R1/4	QS-8	170	130 ... 200	320	320 ... 390	16	8068737	VFOE-LE-T-R14-Q6	1
							8068738	VFOE-LE-T-R14-Q8	1
	QS-10	500	370 ... 500	810	750 ... 900		8068739	VFOE-LE-T-R14-Q10	1
R3/8	QS-8	720	600 ... 900	1150	1300 ... 1500	29.5	8068740	VFOE-LE-T-R38-Q8	1
							8068741	VFOE-LE-T-R38-Q10	1
	QS-10	750	700 ... 1000	1280	1400 ... 1600				
R1/2	QS-12	1200	600 ... 1200	1900	1400 ... 2000	49.5	8068742	VFOE-LE-T-R12-Q12	1
Supply air one-way flow control function									
M5	QS-4	85	50 ... 90	150	130 ... 160	3.3	8068743	VFOE-LS-T-M5-Q4	1
	QS-6	100	60 ... 100	160	150 ... 180		8068744	VFOE-LS-T-M5-Q6	1
M7	QS-4	85	50 ... 90	150	130 ... 160	4	8068745	VFOE-LS-T-M7-Q4	1
	QS-6	100	60 ... 100	160	150 ... 180		8068746	VFOE-LS-T-M7-Q6	1
G1/8	QS-4	165	90 ... 165	260	240 ... 300	9.5	★ 8068747	VFOE-LS-T-G18-Q4	1
							★ 8068748	VFOE-LS-T-G18-Q6	1
	QS-6	170	110 ... 200	270	300 ... 360		★ 8068749	VFOE-LS-T-G18-Q8	1
R1/8	QS-8	170	130 ... 200	270	320 ... 390	9.5	★ 8068750	VFOE-LS-T-R18-Q4	1
							★ 8068751	VFOE-LS-T-R18-Q6	1
	QS-4	165	90 ... 165	260	240 ... 300		★ 8068752	VFOE-LS-T-R18-Q8	1

1) Packaging unit

Datasheet

★ Core Range

Ordering data - Products for battery production

Pneumatic connection		Standard nominal flow rate qnN At 0.6 MPa → 0.5 MPa		Standard flow rate qn At 0.6 MPa → 0 MPa		Weight [g]	Part no.	Type	PU ¹⁾
2	1	In flow control direction [l/min]	In non-return direction [l/min]	In flow control direction [l/min]	In non-return direction [l/min]				
Exhaust air one-way flow control function									
M5	QS-4	90	50 ... 90	150	130 ... 160	3.3	8157642	VFOE-LE-T-M5-Q4-F1A ²⁾	1
	QS-6	105	60 ... 105	160	150 ... 180		8157641	VFOE-LE-T-M5-Q6-F1A ²⁾	1
R1/8	QS-4	150	90 ... 150	250	240 ... 300	9.5	8157640	VFOE-LE-T-R18-Q4-F1A ²⁾	1
	QS-6	165	110 ... 200	280	300 ... 360		8157639	VFOE-LE-T-R18-Q6-F1A ²⁾	1
	QS-8	170	130 ... 200	320	320 ... 390		8157638	VFOE-LE-T-R18-Q8-F1A ²⁾	1
R1/4	QS-6	400	350 ... 450	610	700 ... 800	16	8157637	VFOE-LE-T-R14-Q6-F1A ²⁾	1
	QS-8	500	370 ... 500	810	750 ... 900		8157636	VFOE-LE-T-R14-Q8-F1A ²⁾	1
	QS-10	500	370 ... 500	810	750 ... 900		8157635	VFOE-LE-T-R14-Q10-F1A ²⁾	1
R3/8	QS-8	720	600 ... 900	1150	1300 ... 1500	29.5	8157634	VFOE-LE-T-R38-Q8-F1A ²⁾	1
	QS-10	750	700 ... 1000	1280	1400 ... 1600		8157633	VFOE-LE-T-R38-Q10-F1A ²⁾	1
R1/2	QS-12	1200	600 ... 1200	1900	1400 ... 2000	49.5	8157631	VFOE-LE-T-R12-Q12-F1A ²⁾	1
Supply air one-way flow control function									
M5	QS-4	85	50 ... 90	150	130 ... 160	3.3	8157630	VFOE-LS-T-M5-Q4-F1A ²⁾	1
	QS-6	100	60 ... 100	160	150 ... 180		8157629	VFOE-LS-T-M5-Q6-F1A ²⁾	1
R1/8	QS-4	165	90 ... 165	260	240 ... 300	9.5	8157628	VFOE-LS-T-R18-Q4-F1A ²⁾	1
	QS-6	170	110 ... 200	270	300 ... 360		8157627	VFOE-LS-T-R18-Q6-F1A ²⁾	1
	QS-8	170	130 ... 200	270	320 ... 390		8157626	VFOE-LS-T-R18-Q8-F1A ²⁾	1

1) Packaging unit

2) Recommended for production plants for manufacturing lithium-ion batteries